

VPO

OPERATING MANUAL

SOLENOID DRIVEN METERING PUMPS WITH DIAPHRAGM





TABLE OF CONTENTS

Sommario

1.	GENERAL SAFETY GUIDELINES	6
2.	PURPOSE OF USE AND SAFETY	7
3.	ENVIRONMENTAL SAFETY	9
4.	LABEL	10
5.	SPARE PARTS	11
5.1.	Included Into Package	12
6.	DESCRIPTION	13
6.1.	VPO.....	13
6.2.	Features.....	15
6.3.	Materials.....	17
7.	INSTALLATION	18
7.1.	How to install metering pump.....	18
7.2.	User health and safety	18
7.3.	The work area	19
7.4.	Pump location.....	19
7.5.	Requirements for product positioning.....	20
8.	PIPING CONNECTIONS	21
8.1.	Foot filter / Level probe (included only in some models)	21
8.2.	Suction hose connection	22
8.3.	Pump head / delivery hose assembling procedure.....	22
8.4.	Injection valve.....	23
8.5.	Discharge hose.....	24
8.6.	VAPO PH-RH self venting pump head connection	25
9.	WIRING.....	26

9.1. Preliminary checks	26
9.2. Pump's wiring	27
10. PRIMING.....	28
10.1. Warnings.....	28
10.2. Pump's priming	29
11. VPO CONTROL PANEL	30
11.1. Keyboard function.....	30
12. PROGRAMMING THE PUMP	31
12.1. Start/Power off	31
12.2. Default settings.....	31
12.3. Main menu	31
12.4. Setting menu.....	32
12.5. MODE	32
12.6. SET P	33
12.7. Example	33
12.8. Example	34
12.9. FAST CAL.....	35
12.10. CAL.....	36
12.11. REST CAL	36
12.12. DOS AL	36
12.13. READ AL	37
12.14. STAND-BY.....	37
12.15. OUT AL	38
12.16. DELAY.....	38
12.17. FACTORY	38
12.18. PASSW	38
12.19. LANG.....	39
12.20. MANUAL	39
12.21. ALARMS	40
13. TROUBLESHOOTING	42
13.1. Repair service.....	42

13.2. Fuse replacement procedure.....	43
13.3. Main board replacement procedure.....	43
13.4. Main board	44
14. MAINTENANCE	45
14.1. Maintenance schedule	45
14.2. Maintenance inspection.....	45
14.3. Shutdown procedure.....	47
14.4. Delivery curves.....	47
14.5. Dimensions	52
15. COMPATIBILITY TABLE	53
15.1. Chemical compatibility table	53
15.2. Materials.....	54
15.3. Hose resistance table	54
Table 1 Capacity (manual models).....	16
Table 2 Capacity (self venting models)	17
Table 3 Symbols on display	32
Table 4 Guide to troubleshooting.....	42
Table 5 Chemical compatibility table.	53
Table 6 Hoses features	55
Figure 1 WQA label.....	11
Figure 2 VPO.....	15
Figure 3 Installation.....	20
Figure 4 Level probe assembling diagram.....	21
Figure 5 Suction hose assembling.....	22
Figure 6 Delivery hose / pump head assembling	23
Figure 7 Manual venting pump head model (VPO).....	24
Figure 8 Self-venting models pump head	25
Figure 9 Electrical installation.	26
Figure 10 Wirings.....	27
Figure 11 Main board scheme	44
Figure 12 VPO delivery curves	48
Figure 13 VAPO delivery curves.....	50
Figure 14 Dimensions	52





	<p>This operating instructions contains safety information that if ignored can endanger life or result in serious injury.</p> <p>Read these instructions carefully before use and keep them for future reference. The original instruction is in English. All non-English instructions are translations of the original instruction.</p> <p>Information and specifications on this manual could be uncorrect or could have printing errors.</p> <p>Specifications are subject to change without notice.</p> <p>Version: R1-01-15</p>
	<p>NORME CE EC RULES (STANDARD EC) NORMAS DE LA CE</p> <p>Direttiva Basso Voltaggio } Low Voltage Directive } 2006/95/CE Directiva de baja tensión }</p> <p>Direttiva EMC Compatibilità Elettromagnetica } EMC electromagnetic compatibility directive } 2004/108/CE EMC direttiva de compatibilidad electromagnética }</p> <p>Norme armonizzate europee nell'ambito della direttiva } European harmonized standards underdirective } 2006/42/CE Las normas europeas armonizadas conforme a la direttiva }</p>

1. GENERAL SAFETY GUIDELINES

Operating, installing, or maintaining the unit in any way that is not covered in this manual could cause death, serious personal injury, or damage to the equipment.

ICON

This manual use the following safety message icon:

	<p>Danger!</p> <p>Indicates a hazardous situation which, if not avoided, will result in death or serious injury.</p>
	<p>Warning!</p> <p>Indicates a hazardous situation which, if not avoided, could result in death or serious injury.</p>
	<p>Important</p> <p>A practice not related to personal injury or additional information.</p>
	<p>Cross reference</p> <p>An instance which refers to related information elsewhere in the same document</p>

2. PURPOSE OF USE AND SAFETY

METERING PUMP IS INTENDED FOR CHEMICAL DOSING.

Do not use in explosive area (EX).











Do not use with flammable chemicals.

Do not use with radioactive chemicals.

Use after a proper installation.

Use the pump in accordance with the data and specifications printed on the label.

Do not modify or use in a manner inconsistent with the provisions of the operating manual.

	Keep the pump protected from sun and water. Avoid water splashes.
	In emergencies the pump should be switched off immediately. Disconnect the power cable from the power supply.
	When using pump with aggressive chemicals observe the regulations concerning the transport and storage of aggressive fluids.
	When installing always observe national regulations.
	Manufacturer is not liable for any unauthorized use or misuse of this product that may cause injury, damage to persons or materials.
	Pump must be accessible at all times for both operating and servicing. Access must not be obstructed in any way.
	Feeder should be interlocked with a no-flow protection device to automatically shut-off the pumps when there is no flow!
	Adequate measures shall be taken to prevent cross connection of chemicals!
	Chemical feeding must be stopped during backwash cycles and periods of noflow as these conditions may introduce the potential for chemical overdosing. Not doing so may result in elevated chemical concentrations and hazardous gas introduction into the pool or spa.
	Pump and accessories must be serviced and repaired by qualified and authorized personnel only.



Before any operation:

- always read chemical Material Safety Data Sheet (MSDS);
- always wear protective clothing;
- always discharge the liquid end before servicing the pump.
- empty and rinse the liquid end before work on a pump which has been used with hazardous or unknown chemicals.

3. ENVIRONMENTAL SAFETY

Work area

Always keep the pump area clean to avoid and/or discover emissions.

Recycling guidelines

Always recycle according to these guidelines:

1. If the unit or parts are accepted by an authorized recycling company, then follow local recycling laws and regulations.
2. If the unit or parts are not accepted by an authorized recycling company, then return them to the nearest representative.

Waste and emissions regulations

Observe these safety regulations regarding waste and emissions:

- Dispose appropriately of all waste.
- Handle and dispose of the dosed chemical in compliance with applicable environmental regulations.
- Clean up all spills in accordance with safety and environmental procedures.
- Report all environmental emissions to the appropriate authorities.

4. LABEL

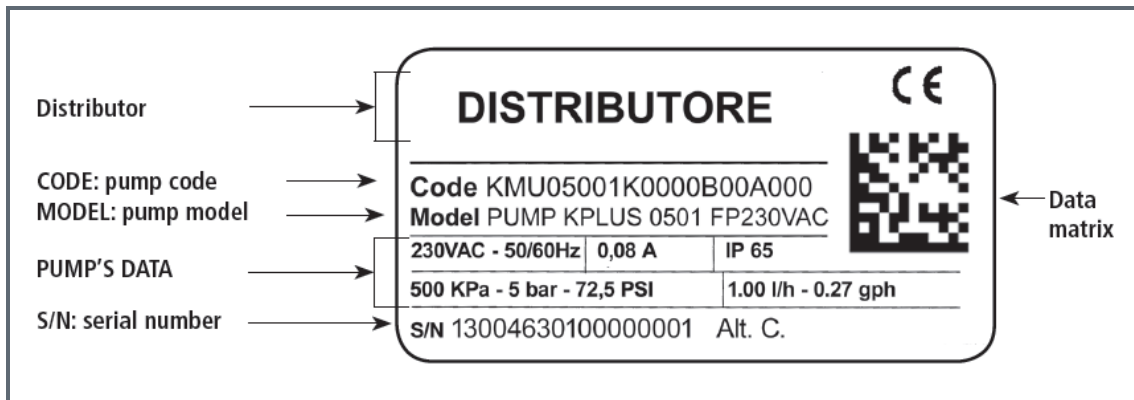

5. SPARE PARTS



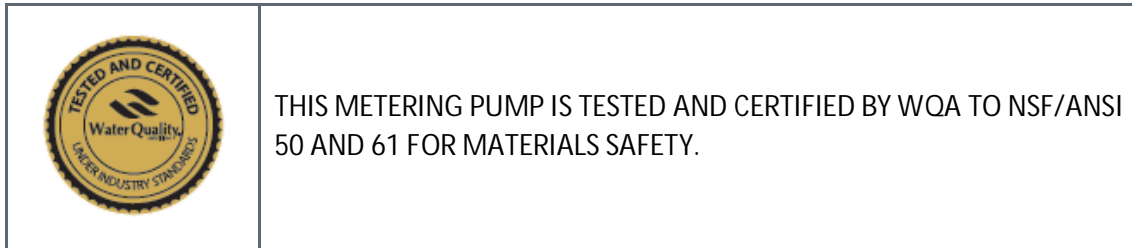

For spare parts orders or any other communication, refer to the pump's label.

Code (CODE) and serial number (S / N) uniquely identify the pump.

Figure 1 WQA label.



Transportation and Storage

	<p>A not suitable transportation or storage can cause damages.</p> <p>Use original box to pack the pump.</p> <p>Observe storage conditions also for transportation.</p> <p>Although packed, always protect the unit against humidity and the action of chemicals.</p>
	<p>Before return the dosing pump to the manufacturer Repair service, drain the chemical from pump head and rinse it. Refer to  Shutdown procedure.</p> <p>Fill the PRODUCT SERVICE REPAIR FORM and send it with the dosing pump.</p> <p>Repair service is not accepted if PRODUCT SERVICE REPAIR FORM is missing.</p>
	<p>DO NOT TRASH PACKAGING. USE IT TO RETURN THE PUMP.</p>

Transportation and storage temperature..... 10 ÷ 50°C (32 ÷ 122°F)

Umidity..... 95% relative humidity (not condensed)

5.1. Included Into Package

QUANTITY	CONTENT	VPO
n. 2	ø6 dibbles	●
n. 2	4,5 x 40 self tapping screws	●
n. 1	5 X 20 delayed fuse	●
n. 1	level probe with axial foot filter (PVDF)	●
n. 1	0,3 bar injection valve (PVDF)	●
m 2	delivery hose (PVDF)	●
m 2	suction hose (PE)	●
m 2	discharge hose (PVC 4x6 transparent)	●
m 2,5	input signal cable	●
n. 1	operating manual	●

6. DESCRIPTION

6.1. VPO

VPO is a proportional dosing pump with level control.

It is driven by internal built-in pH or Redox (ORP) meter (electrode not included).

Ranges:

pH: 0 ÷ 14 pH

ORP: -999mV ÷ +999mV

FEATURES

Select pH or ORP parameter by menu: choose MODE and set pH or ORP.

In both modes, the pump can be set to dose in on / off or proportional.

In On / Off mode, the pump operates in two values (set-point)

In proportional mode the pump doses proportionally into the set point.

Fast calibration

You can perform a fast calibration on standard value.

7.0 and 4.0 for pH, 650 mV for ORP. For different value proceed to a full calibration.

Restore last calibration

If an error occur during calibration you can restore last calibration saved.

Alarms

Dosing, reading (probe failure), level and stand-by.

Alarm output status: N.O. or N.C.

DELAY

Programmable delay at dosing start up.

RESTORE FACTORY

Restore factory value (default value).

PASSWORD AND LANGUAGE

Settable password and language (EN or FR).

STAND-BY

Stand-by INPUT.



	VERIFY CHEMICAL COMPATIBILITY OF PUMP HEAD, O-RING AND HOSES BEFORE USE.
	Refer to  Chemical Compatibility table.

Figure 2 VPO



6.2. Features

Power Supply	Fuse	Frequency
230 VAC (180-270 VAC)	800 mA	50/60 Hz
115 VAC (90-135 VAC)	400 mA	
24 VAC (20-32 VAC)	2 A	/
12 VDC (10-16 VDC)	3,15 A	

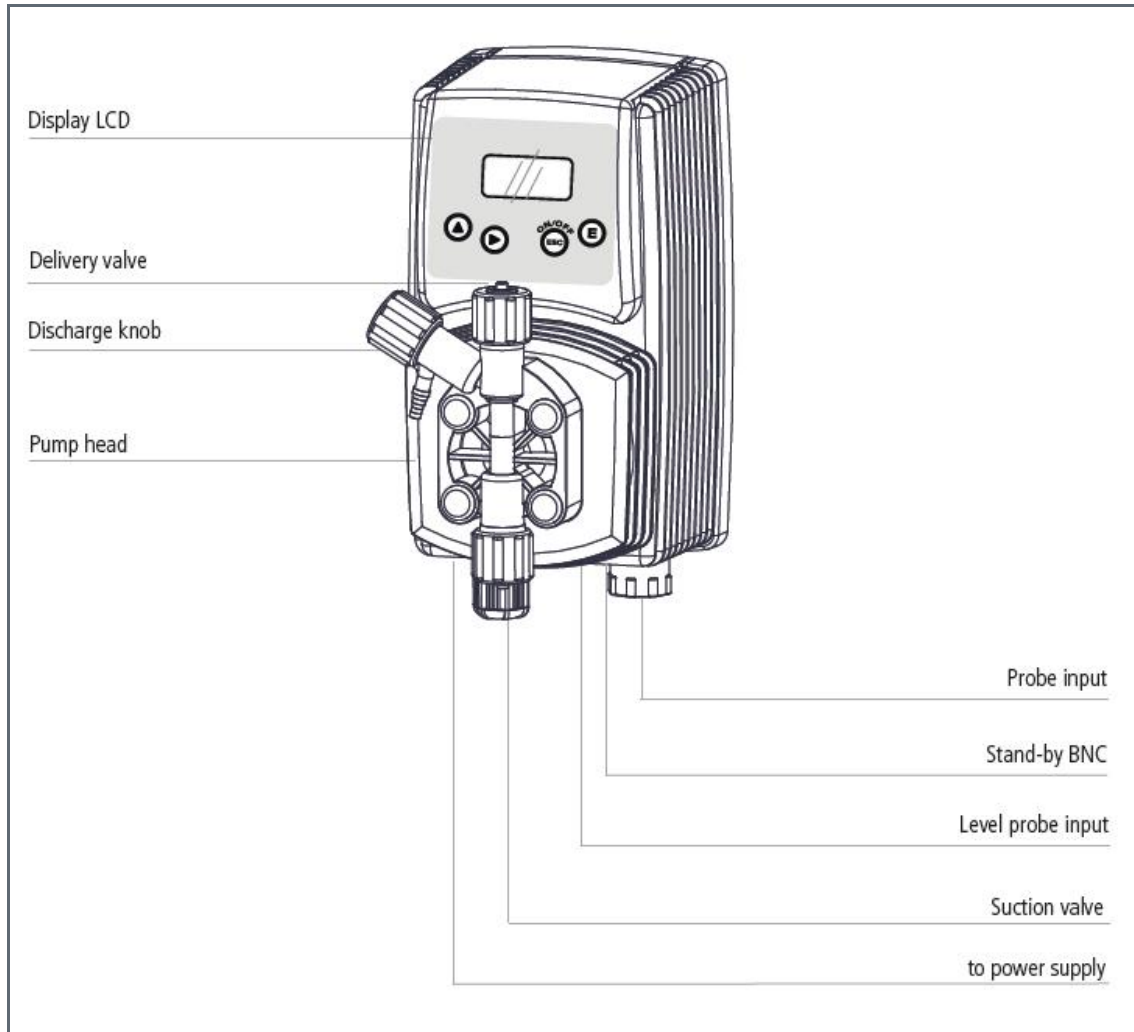
Environment temperature	10 ÷ 45°C (32 ÷ 113°F)
Chemical temperature	0 ÷ 50°C (32 ÷ 122°F)
Transportation and storage temperature	10 ÷ 50°C (32 ÷ 122°F)
Installation class	II

Pollution level	2
Audible noise	73dbA
Protection degree	IP 65
Dimensions	225x215x125mm
Max installation height	1,5 m
Capacity	☰ Table 1-2

Table 1 Capacity (manual models)

Model	FLOW				Cc per STROKE	pulse/ min	Maximum pressure		Hoses	
	min cc/h	max l/h	Min GPH	Max GPH			bar	PSI	delivery (PE)	suction (PVC)
2001	30	1	0,008	0.26	0,1	180	20	290	4x8	4x8
1802	60	2	0,02	0.52	0,19	180	18	261	4x8	4x8
1804	110	4	0,03	1.05	0,37	180	18	261	4x8	4x8
1502	60	2	0,02	0.52	0,19	180	15	217	4x6	4x6
1504	110	4	0,03	1.05	0,37	180	15	217	4x6	4x6
1505	140	5	0,04	1.32	0,46	180	15	217	4x6	4x6
1004	110	4	0,03	1.05	0,37	180	10	145	4x6	4x6
1005	140	5	0,04	1.32	0,46	180	10	145	4x6	4x6
1010	280	10	0,07	2.64	0,93	180	10	145	4x6	4x6
0706	170	6	0,04	1.58	0,56	180	7	101	4x6	4x6
0510	280	10	0,07	2.64	0,93	180	5	72	4x6	4x6
0512	330	12	0,09	3.17	1,11	180	5	72	4x6	4x6
0501	30	1	0,008	0.26	0,1	180	5	72	4x6	4x6
0408	220	8	0,06	2.11	0,74	180	4	58	4x6	4x6
0310	280	10	0,07	2.64	0,93	180	3	43	4x6	4x6
0217	470	17	0,12	4.49	1,57	180	2	29	6x8	6x8 (PE)
0116	440	16	0,11	4.22	1,48	180	1	14	6x8	6x8 (PE)

Table 2 Capacity (self venting models)

Model	FLOW				Cc per STROKE	pulse/ min	Maximum pressure		Hoses	
	min cc/h	max l/h	Min GPH	Max GPH			bar	PSI	delivery (PE)	suction (PVC)
200,5	0,05	0,5	1,32*10 ⁻⁵	0,13	0,05	180	20	290	4x8	4x8
1802	0,19	2	5*10 ⁻⁵	0,52	0,19	180	18	261	4x8	4x8
1503	0,28	3	7,4*10 ⁻⁵	0,79	0,28	180	15	217	4x6	4x6
1501	0,1	1	2,6*10 ⁻⁵	0,26	0,1	180	15	217	4x6	4x6
103,4	0,32	3,4	8,5*10 ⁻⁵	0,89	0,32	180	10	145	4x6	4x6
1007	0,65	7	0,00017	1,84	0,65	180	10	145	4x6	4x6
1002	0,19	2	5*10 ⁻⁵	0,52	0,19	180	10	145	4x6	4x6
0704	0,37	4	9,8*10 ⁻⁵	1,05	0,37	180	7	101	4x6	4x6
057,5	0,7	7,5	0,00018	1,98	0,7	180	5	72	4x6	4x6
0509	0,84	9	0,00022	2,37	0,84	180	5	72	4x6	4x6
045,5	0,51	5,5	0,00013	1,45	0,51	180	4	58	4x6	4x6
0307	0,65	7	0,00017	1,84	0,65	180	3	43	4x6	4x6
0213	1,2	13	0,00031	3,43	1,2	180	2	29	6x8	6x8 (PE)
0113,5	1,25	13,5	0,00033	3,56	1,25	180	1	14	6x8	6x8 (PE)

6.3. Materials

✓ : standard

✗ : options available

	PVDF	PP	PPVO	PMMA	PVC	PE	CE	VETRO	PTFE	SS	FKM B	EPDM	WAX	SI
BOX		✓	✗											
PUMP HEAD	✓			✗										
DIAPHRAGM									✓					
BALLS						✓	✗	✗	✗					
SUCTION HOSE	✗				✓	✗								
DELIVERY HOSE	✗				✗	✓								
DISCHARGE HOSE	✗				✓	✗								
O RING									✗		✗	✗	✗	✗
LEVEL PROBE/ FOOT FILTER	✓													
LEVEL PROBE CABLE						✓								

7. INSTALLATION



7.1. How to install metering pump

5 steps to install and start-up the pump:

1. Pump location
2. Piping connections (hoses, level probe, injection valve)
3. Wirings
4. Pump priming
5. Programming and start-up

The operator must be aware of safety precautions to prevent physical injury.

7.2. User health and safety



	<p>POWER SUPPLY DISCONNECTION</p> <p>Disconnect power supply before you perform any installation or maintenance tasks. Failure to disconnect power will result in serious physical injury.</p>
	<p>SAFETY EQUIPMENT</p> <p>Use safety equipment according to the company regulations. Use this safety equipment within the work area:</p> <ul style="list-style-type: none">▪ Helmet▪ Safety goggles (with side shields)▪ Protective shoes▪ Protective gloves▪ Gas mask

7.3. The work area

	<p>THE WORK AREA</p> <p>Observe these regulations and warnings in the work area:</p> <ul style="list-style-type: none">▪ Always keep the work area clean.▪ Pay attention to the risks presented by gas and vapors in the work area.▪ Avoid all electrical dangers. Pay attention to the risks of electric shock or arc flash hazards.▪ Avoid water splashes and direct sun!
---	---

7.4. Pump location

Pump must be installed on a stable support at a max 1,5 mt height from tank's bottom.

	<p>Injection point must be higher than tank to avoid accidental chemical injection.</p> <p>Otherwise, connect a multifunction valve on delivery pipeline.</p>
	<p>INSTALLATION PUMP GUIDELINES</p> <p>Install the pump</p> <ul style="list-style-type: none">▪ in a safety place and fixed to the table / wall to avoid vibration problems;▪ in an easy accessible place;▪ in horizontal position.
	<p>Use only hoses compatibles with product to dose.</p> <p>See "Chemical compatibility table" page 31.</p> <p>If dosing product is not listed please consult full compatibility table or contact chemical's manufacturer.</p>

7.5. Requirements for product positioning

	<p>REQUIREMENTS FOR PRODUCT POSITIONING</p> <p>Only use fasteners of the proper size and material.</p> <p>Replace all corroded fasteners.</p> <p>Make sure that all fasteners are properly tightened and that there are no missing fasteners.</p>
---	--

Figure 3 Installation



8. PIPING CONNECTIONS

8.1. Foot filter / Level probe (included only in some models)

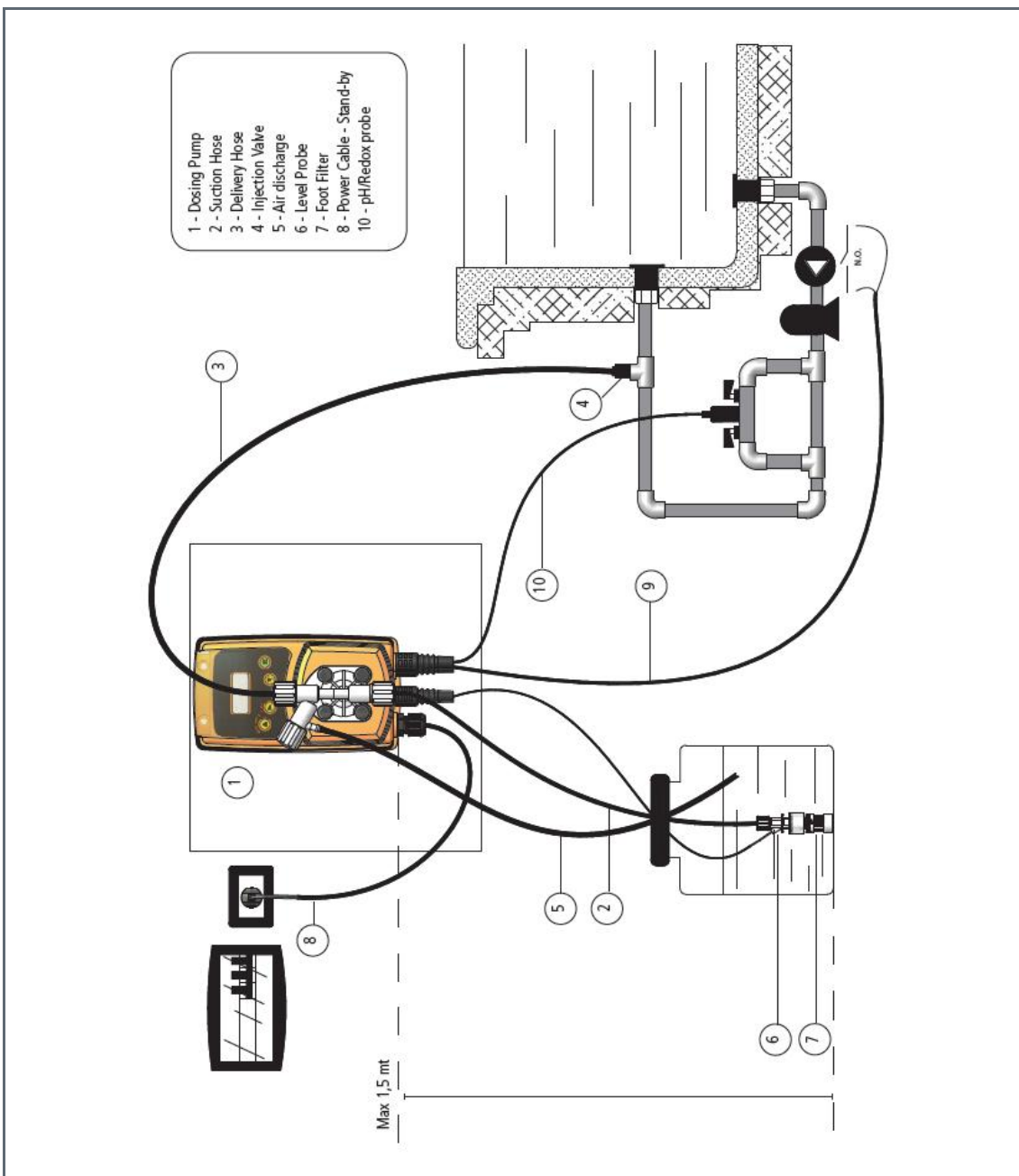
Level probe is assembled with a foot filter that avoid sediments priming problems.

Install level probe on the bottom of the tank.

Connect BNC level probe to the pump BNC input.

	<p>Warning: If there is a mixer installed into tank, install a suction lance instead of level probe / foot filter.</p> <p>In case of replacement of level probe parts, follow the diagram below.</p>
---	--

Figure 4 Level probe assembling diagram.



8.2. Suction hose connection

⚠	<p>Suction piping should be as short as possible and installed in vertical position to avoid air bubbles suction.</p> <p>Completely unscrew tightening nut from pump's head and remove assembling components: tightening nut, holding ring and pipe holder.</p> <p>Assembly as shown in fig. 4.</p> <p>Insert hose into pipe holder until it reaches the bottom. Lock hose on pump's head by screwing down the tightening nut.</p>
⚠	<p>Hand-tighten the nuts firmly.</p> <p>Do not use tongs or any other tool.</p>

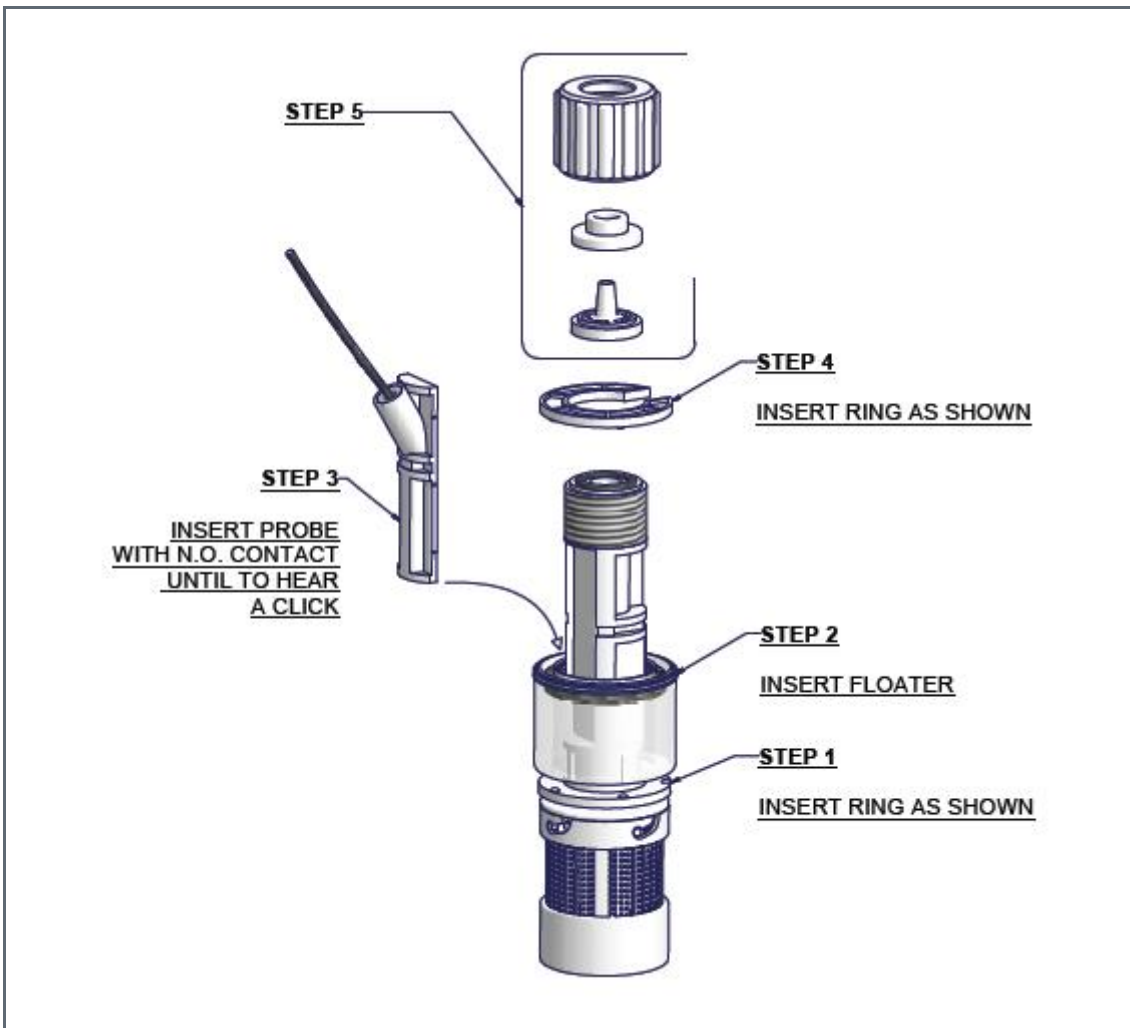
Figure 5 Suction hose assembling

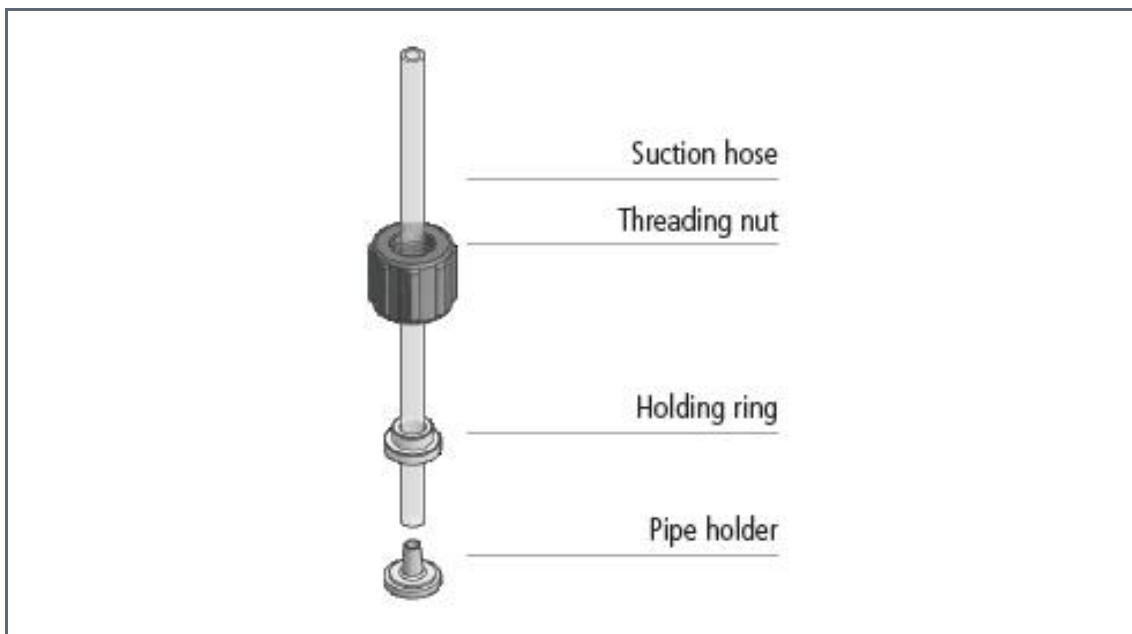

8.3. Pump head / delivery hose assembling procedure

!	<p>Suction and delivery valves must be in vertical position.</p>
⚠	<p>Delivery hose must be firmly fixed to avoid suddenly movements that could damage near objects</p>

	<p>Completely unscrew tightening nut from pump's head and remove assembling components: tightening nut, holding ring and pipe holder.</p> <p>Assembly as shown in fig.5.</p> <p>Insert hose into pipe holder until it reaches the bottom. Lock hose on pump's head by screwing down the tightening nut.</p>
<p>!</p>	<p>Hand-tighten the nuts firmly.</p> <p>Do not use tongs or any other tool.</p> <p>Connect the other end of the hose to the injection valve using the same procedure.</p>

Figure 6 Delivery hose / pump head assembling

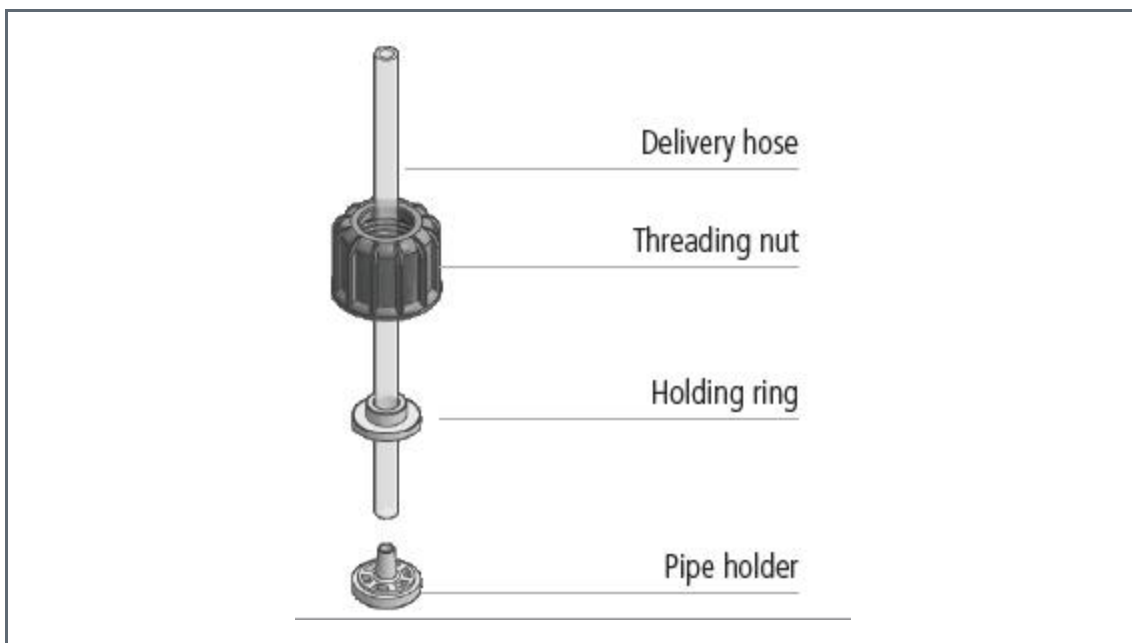

8.4. Injection valve

Injection valve must be installed on plant from water's input.

Injection valve will open at pressure greater than 0,3 bar.

On request 1, 2, 3, 4 or 5 bar injection valve are available.

8.5. Discharge hose

Insert one side of discharge hose into discharge connector as shown in fig below.

Insert other side of discharge hose into product's tank.

During priming procedure product exceeding will flow into tank.

Figure 7 Manual venting pump head model (VPO).

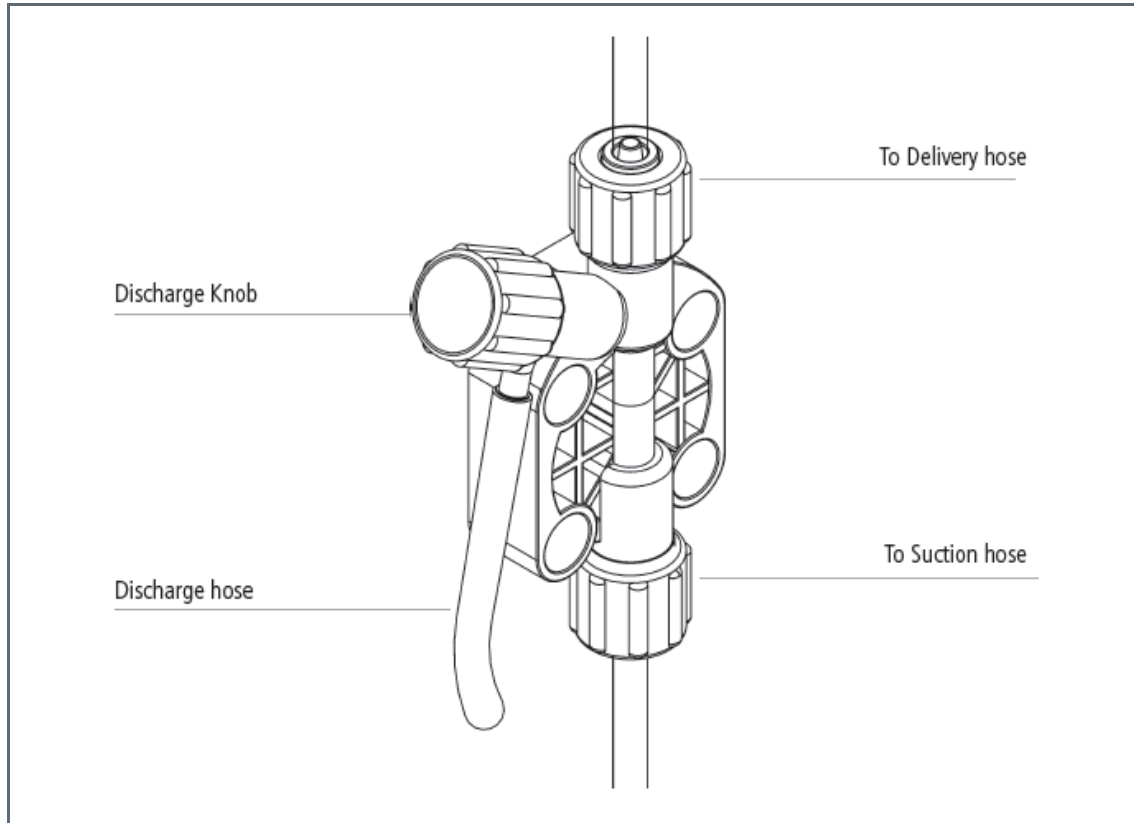

For priming procedure see PRIMING.

it's allowed to lightly bend discharge hose.



During calibration procedure ("TEST") insert discharge hose into BECKER test-tube.

8.6. VAPO PH-RH self venting pump head connection

Refer to fig. below for delivery and discharge hose.

Assembling procedures are the same described before.

Figure 8 Self-venting models pump head

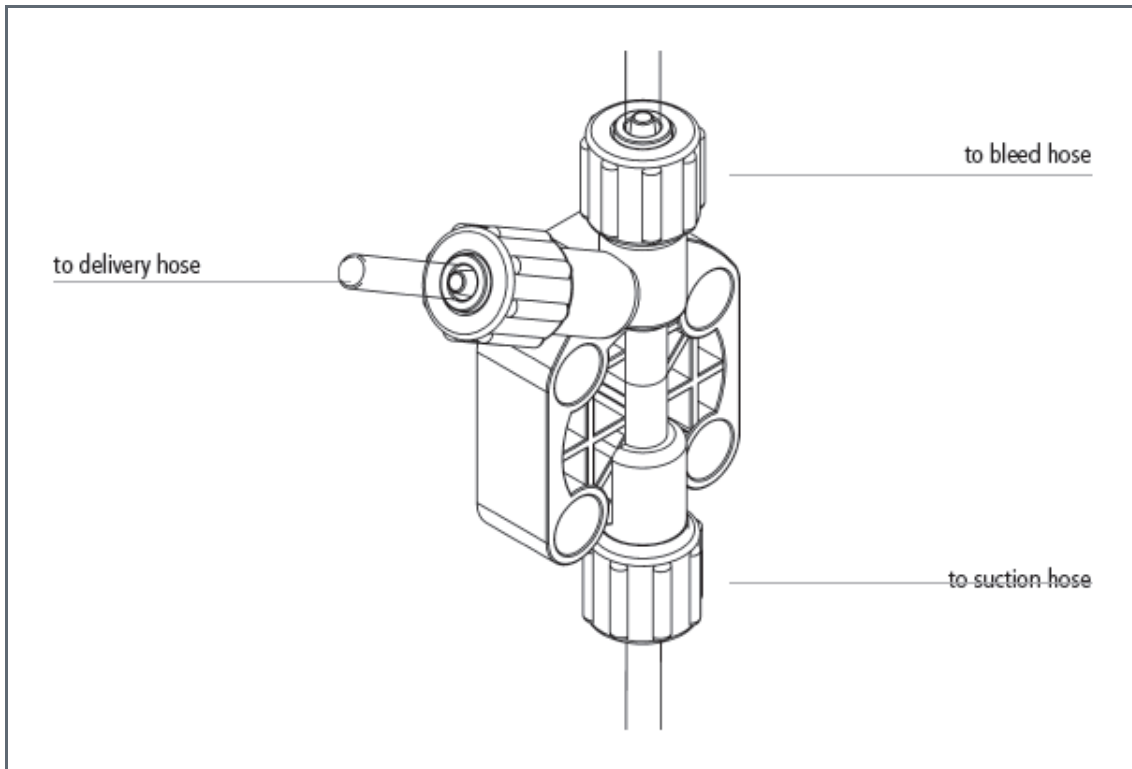

	Suction, delivery and discharge valve are different.
--	--

9. WIRING

9.1. Preliminary checks

	THE ELECTRICAL WIRINGS SHOULD BE CARRIED OUT BY AUTHORIZED AND QUALIFIED PERSONNEL ONLY IN ACCORDANCE WITH LOCAL REGULATIONS.
---	---

Before to proceed, verify the following steps:

1. Verify the data on nameplate.
Make sure that the electrical data on the nameplate of the motor corresponds to the electrical supply.
2. Verify the grounded power outlet.
The pump must be plugged to a grounded power outlet. Pump must be connected to a motor protection switch (Residual Current Circuit Breaker - MCCB).
3. Install a relay switch. Do not install it in parallel with heavy inductance load (for example: engines). See fig. below.

Figure 9 Electrical installation.

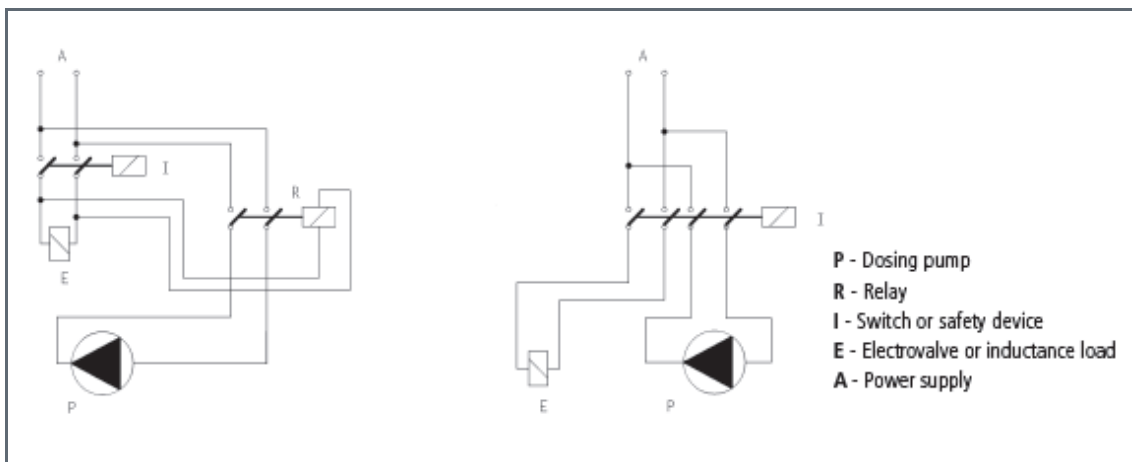

4. Verify peak Amps. 115 or 230 VAC pumps do not use motor overload protection.

Power supply	
12 VDC	connect the pump to a 55 Ah-12VDC battery
24 VDC	connect the pump to a 200W stabilized power supply (verify peak Amps)

5. Verify level probe "BNC" is connected as described in  "Foot filter / Level probe".

9.2. Pump's wiring

Connect pH or ORP probe "BNC" to pump probe input.



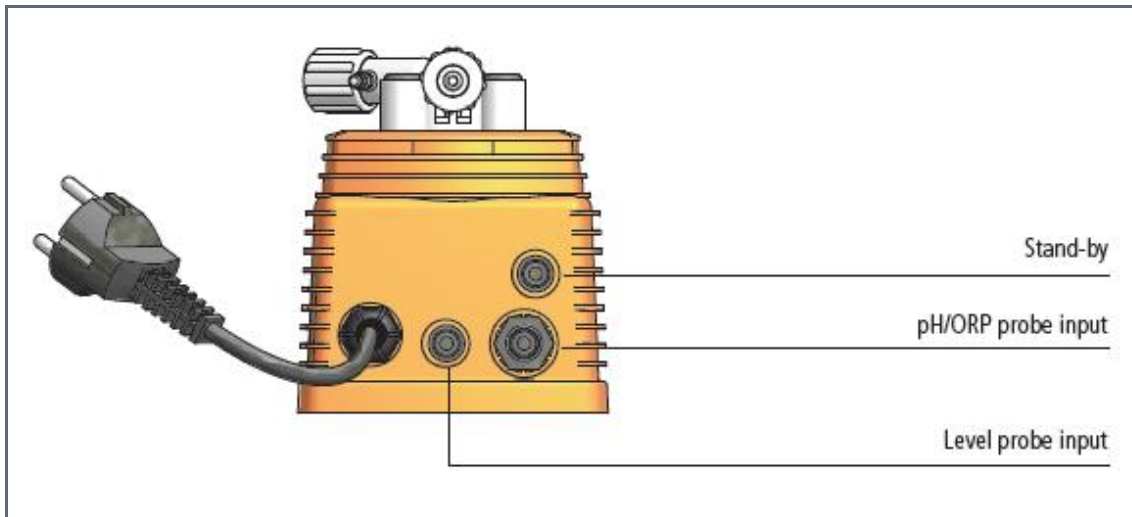

Connect level probe to pump level probe input.

Figure 10 Wirings



10. PRIMING

10.1. Warnings

	Feeder should be interlocked with a no-flow protection device to automatically shut-off the pumps when there is no flow!
	Adequate measures shall be taken to prevent cross connection of chemicals!
	Chemical feeding must be stopped during backwash cycles and periods of noflow as these conditions may introduce the potential for chemical overdosing. Not doing so may result in elevated chemical concentrations and hazardous gas introduction into the pool or spa.
	Never operate any pumping system with a blocked suction and discharge. You must take all necessary measures to avoid this condition.
	<p>SAFETY EQUIPMENT</p> <p>Use safety equipment according to the company regulations. Use this safety equipment within the work area:</p> <ul style="list-style-type: none">▪ Helmet▪ Safety goggles (with side shields)▪ Protective shoes▪ Protective gloves▪ Gas mask

10.2. Pump's priming

To prime the pump:

1. perform all pipings (delivery, suction and discharge hose);
2. turn completely the discharge knob to open discharge valve;
3. supply the pump and turn on
4. set MANUAL (refer to  Setting menu).
5. When the product will start to flow into discharge hose, close the discharge valve turning the knob (not for self-venting model).

For viscous liquids, to facilitate priming: insert a 20 cc syringe on venting pipe and suck;

When syringe is almost full close the discharge valve turning the knob.

11. VPO CONTROL PANEL

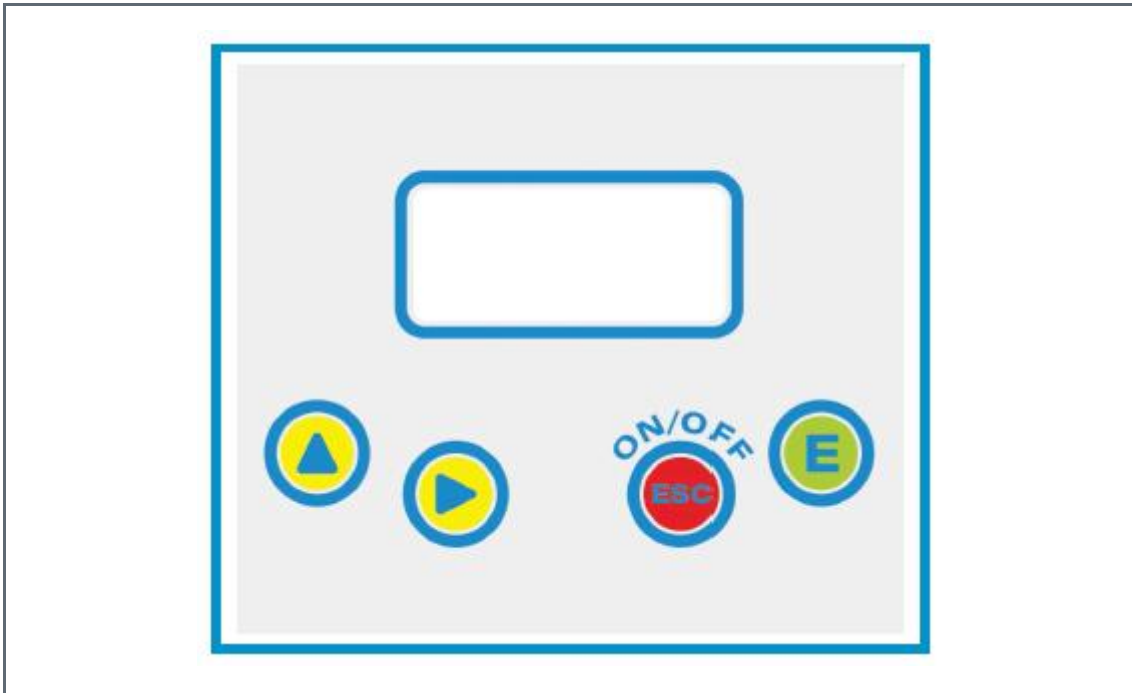

11.1. Keyboard function

↑	SCREENS SCROLL / NUMBER INCREASING
→	CHANGE FIELD ON THE SAME SCREEN
ESC	ON/OFF / EXIT OR BACK WITHOUT SAVE
E	SELECT / CONFIRM / SAVE

12. PROGRAMMING THE PUMP

12.1. Start/Power off

Connect power supply cable and start the pump with ON/OFF key.

Display will be on (default settings).

Mode OFF: press OFF to switch off the pump.

Unplug power supply to complete the power off.

12.2. Default settings

PASSW	PASSWORD	0000
LANG	LANGUAGE	FRENCH
OUT AL	OUT ALARM	N.O.
STAND-BY	STAND-BY	DISABLE TIME 00 MIN
DOS AL	DOSING ALARM	TIME 0h 00min - STOP no
READ AL	READING ALARM	TIME 0h 00min - STOP no
SET P pH	SETPOINT pH	PROP - pH1 7,5 50% - pH2 7,3 0%
SET P ORP	SETPOINT ORP	PROP - ORP1 700 50% - ORP2 730 0%

12.3. Main menu

Use  to scroll main menu.

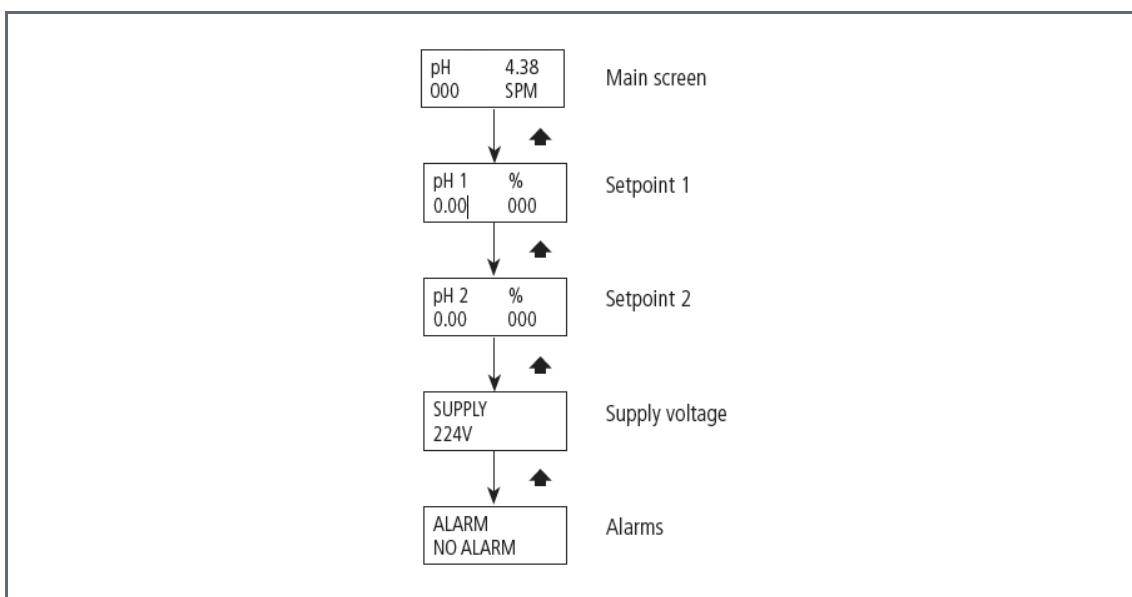

Table 3 Symbols on display

#	one or more alarms occur (🚨 ALARMS).
---	--------------------------------------

Press **↑** to delete alarm messages on display.

12.4. Setting menu

Settings

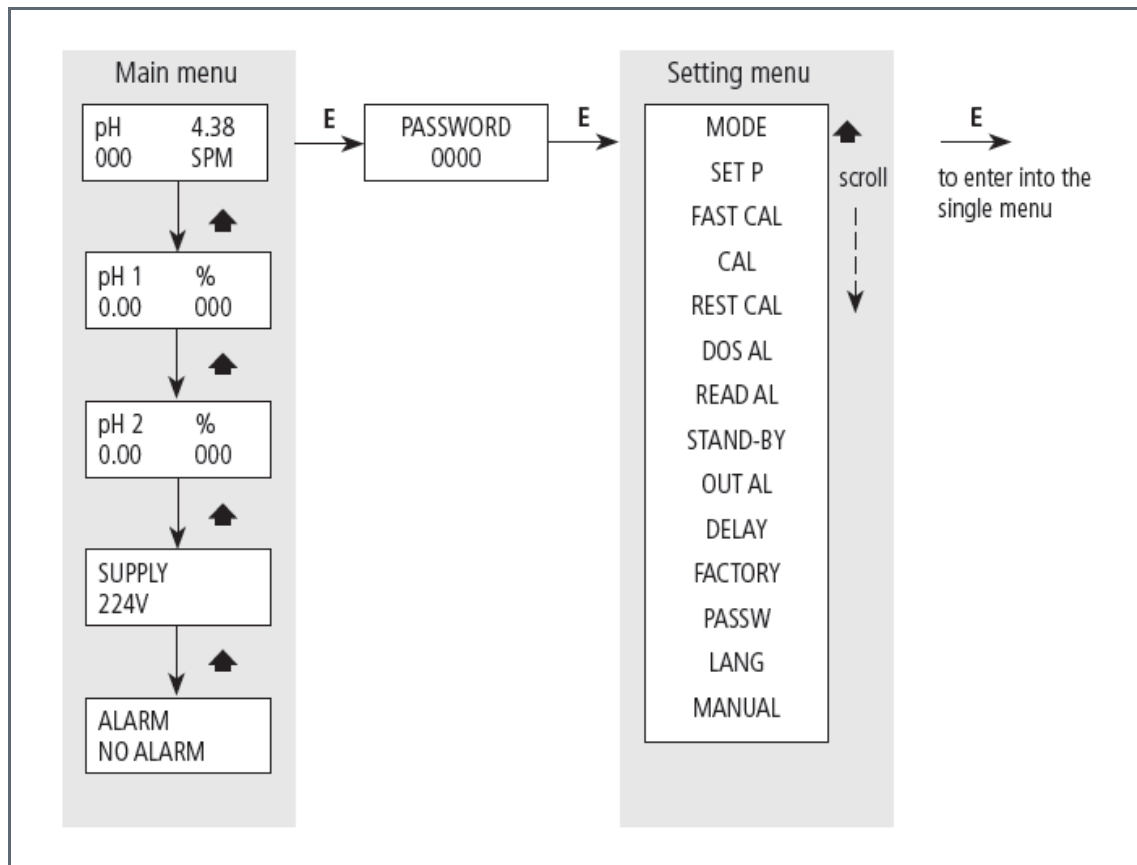

12.5. MODE

Set the pump working mode between pH and ORP.

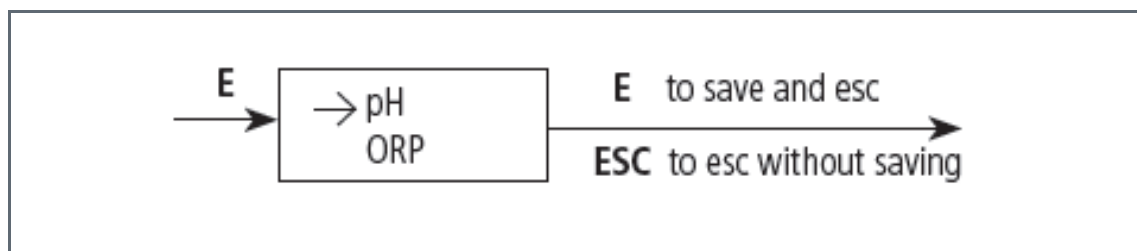

12.6. SET P

Set the pump working mode between ON/OFF or PROPORTIONAL and the ranges for on/off dosing or proportional dosing. % refer to pump stroke/minute.

In ON/OFF mode the pump works using two set values that enable or disable the pump.

Regulate Low value on 0% for pump off. Only in exceptional cases and for special applications regulate low value on a percentage different from 0%.

If pH pump:

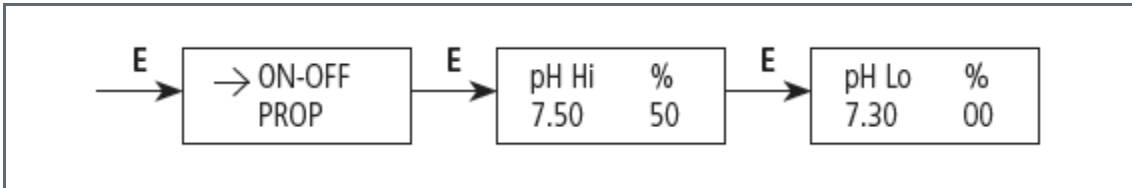

If ORP pump:

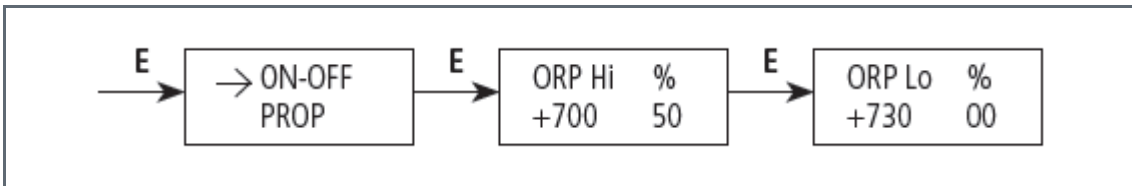

12.7. Example

Pump working in ON/OFF mode:

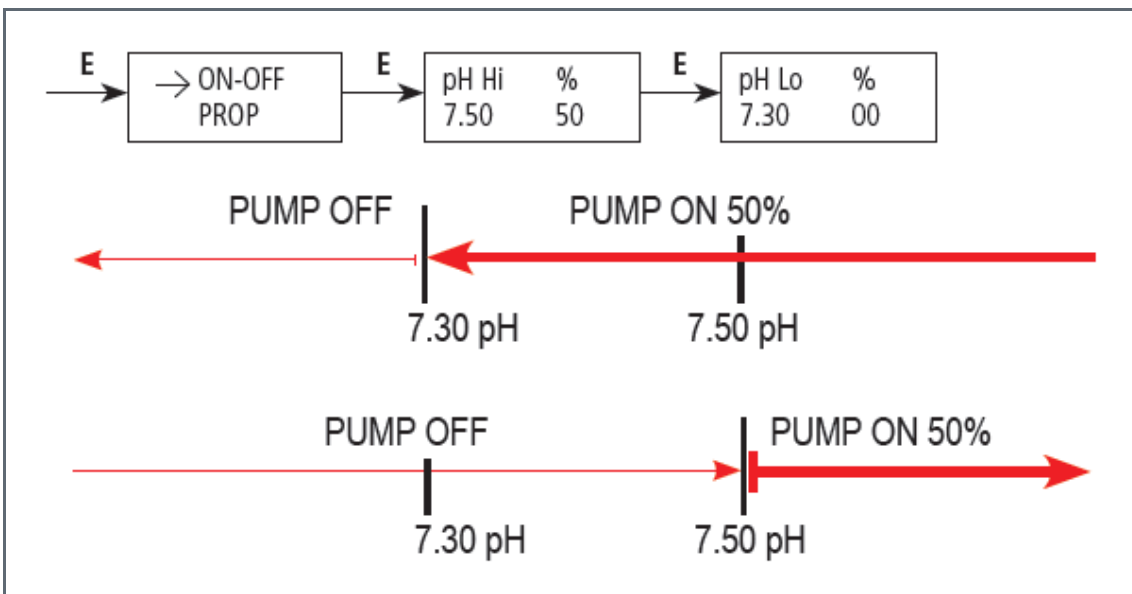

In PROPORTIONAL mode the pump works proportionally in the set range.

Regulate Low value on 0% for pump off. Only in exceptional cases and for special applications regulate low value on a percentage different from 0%.

If pH pump:

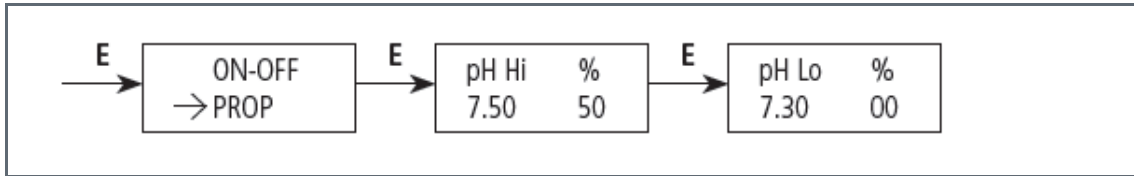

If ORP pump:

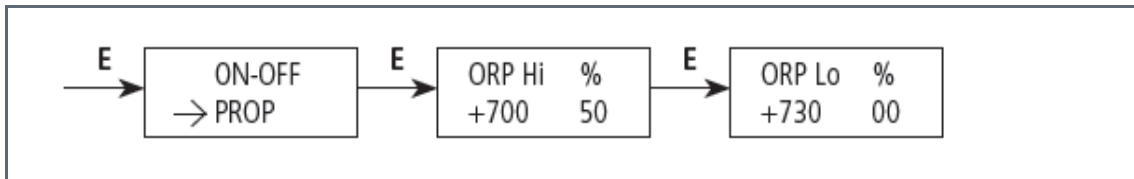

12.8. Example

Pump working in PROPORTIONAL mode

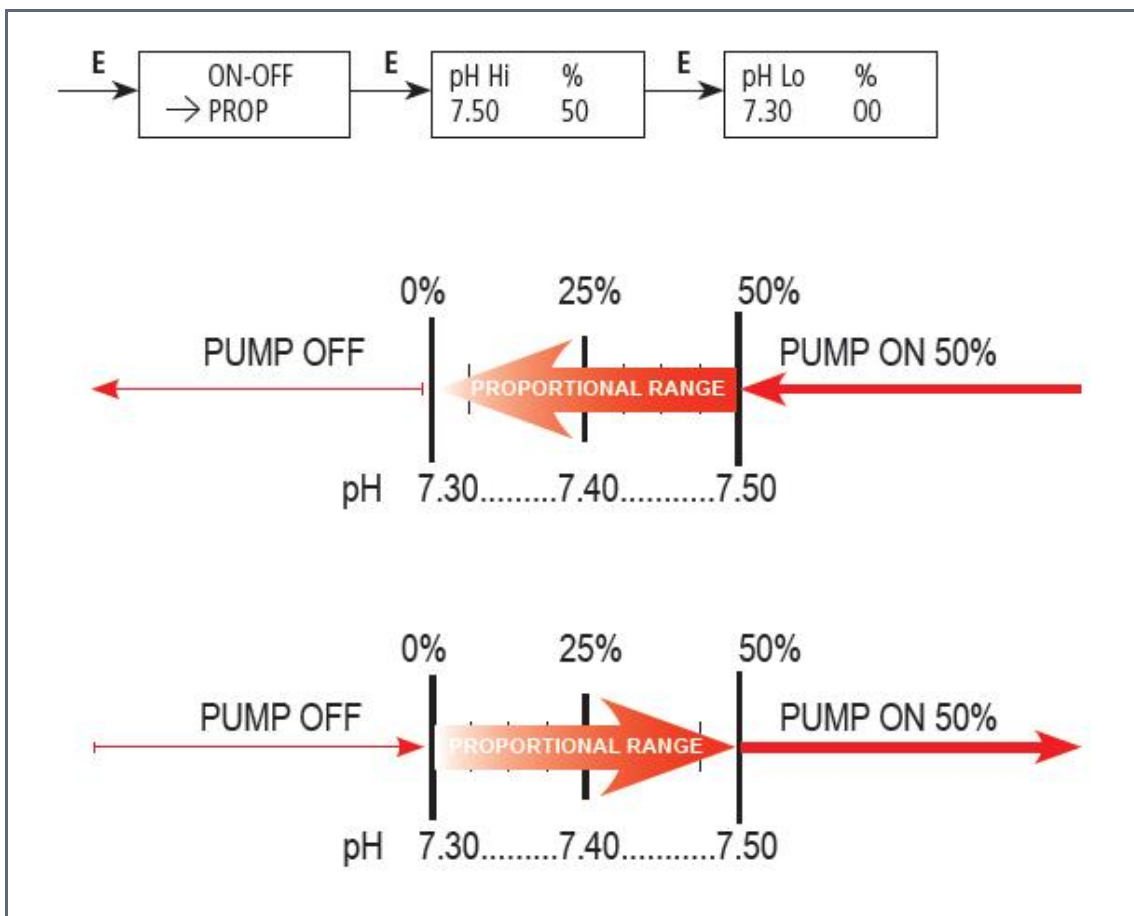

12.9. FAST CAL

Set FAST CAL to perform a fast calibration on standard value: 7pH and 4pH or 650mV.

In order to perform a fast calibration, you need:

- 7 pH buffer solution
- 4 pH buffer solution

or

- 650 mV buffer solution

If pH pump:

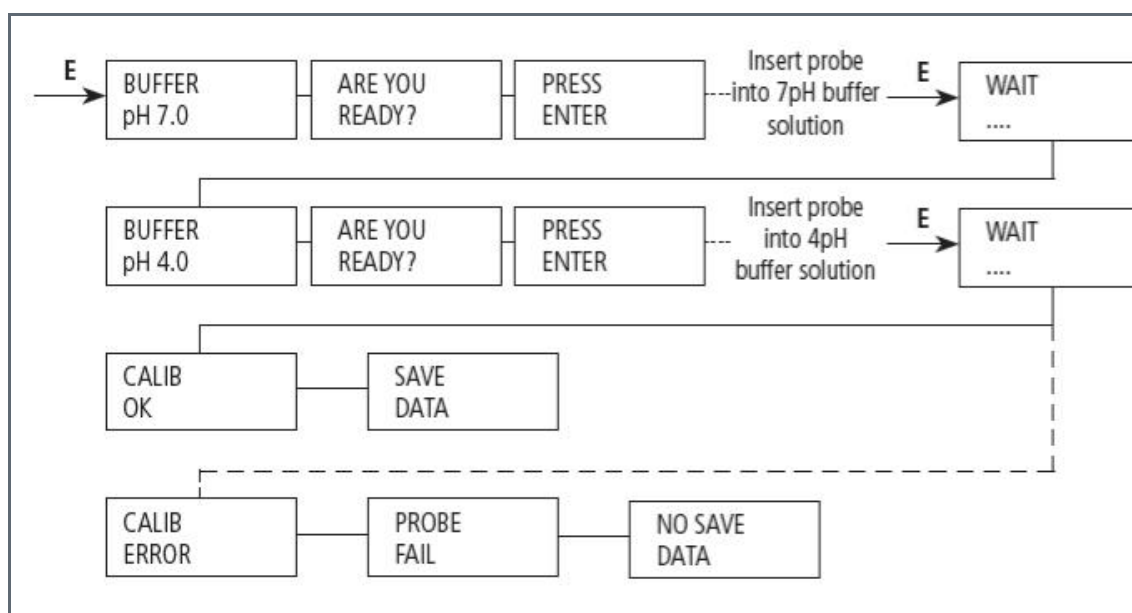

If ORP pump:

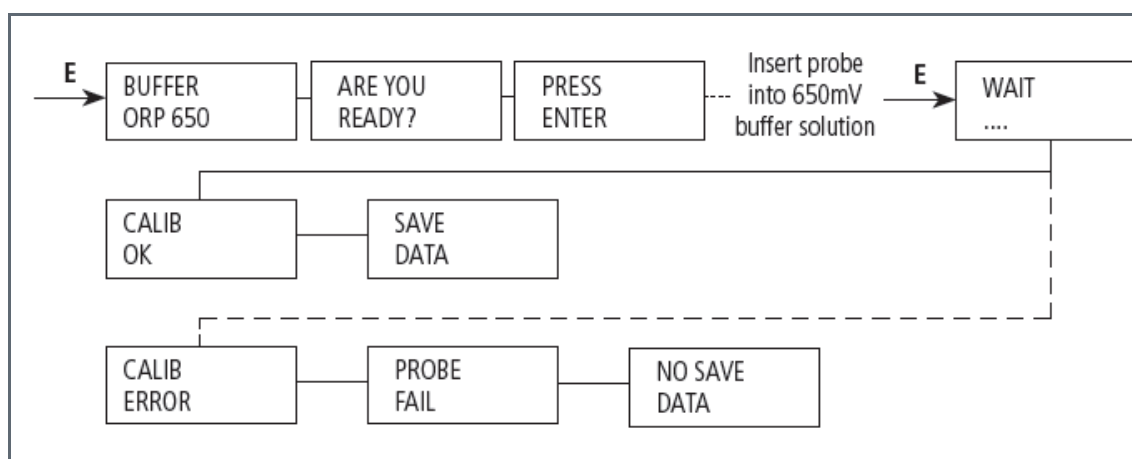

12.10.CAL

Set CAL to perform a classic calibration on 2 points if pH pump or on 1 point if ORP pump.

In order to perform a complete calibration, you need:

- two pH buffer solutions

or

- a mV buffer solution.

If pH pump:

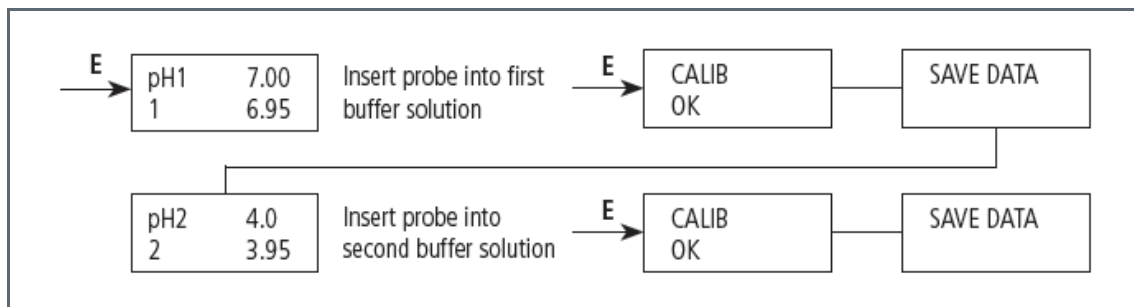

If ORP pump:

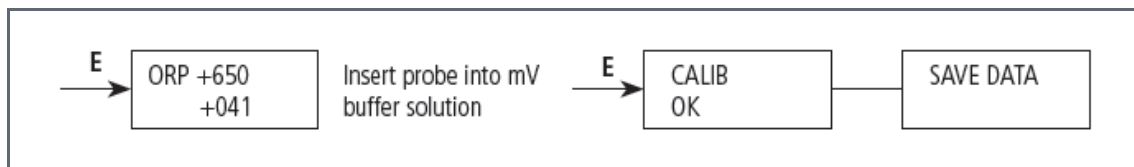

12.11.REST CAL

Set REST CAL to restore the LAST calibration saved.

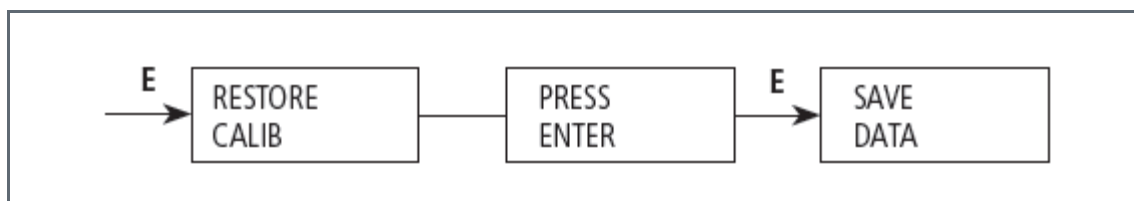

12.12.DOS AL

DOSING ALARM set a maximum dosing time alarm (max 9 h 99 min). This alarm prevents the pump to dose if a set time is reached.

If pump doses over the time, an alarm occurs.

If the dosing alarm occurs, the pump can be stopped or not (select STOP YES or NO).

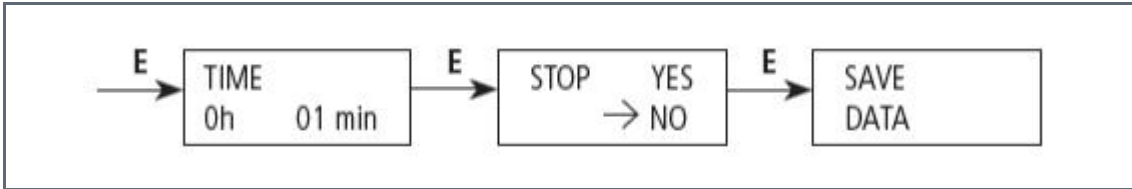

12.13.READ AL

READING ALARM set a probe reading alarm (max 9 h 99 min). This alarm prevents against probes failures.

If the value read by probe does not change for the time set, an alarm occurs.

If the reading alarm occurs, the pump can be stopped or not (select STOP YES or NO).

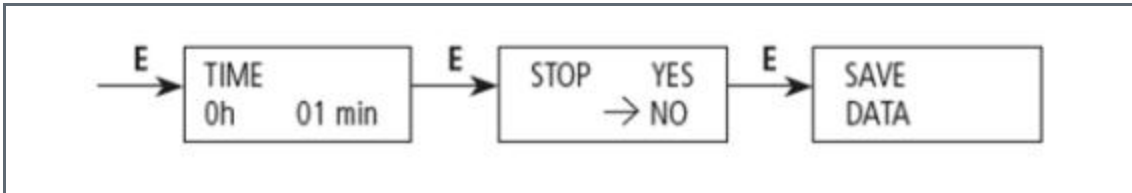

12.14.STAND-BY

STAND-BY set an input to stop the pump.

Set a delay (max 99 min) to wait a reasonable time after alert.

The stand by input can be set on:

- "Direct" (N.O.) activates the standard input;
- "Reverse" the digital logic is inverted;
- "Disable" the input is not enabled.

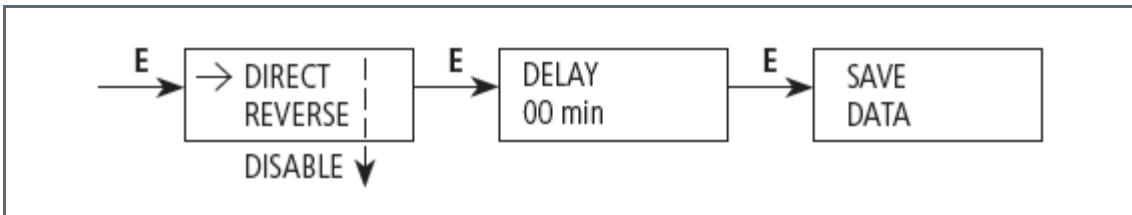

12.15.OUT AL

OUT AL set alarm relais status. This contact can be set as:

- N.O. contact;
- N.C. contact.

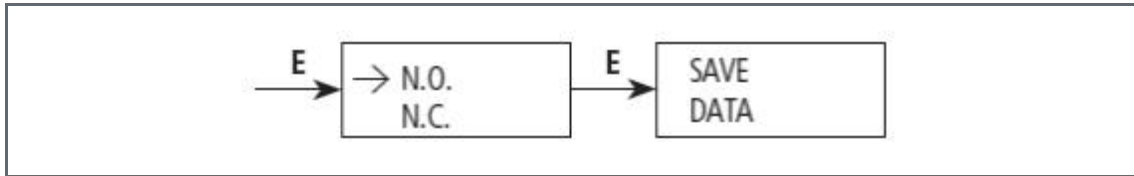

12.16.DELAY

DELAY set a waiting time after pump supply. It is suggested to wait a reasonable time for probe polarization. You can interrupt this delay by pressing ESC key to cancel the remaining time. Max delay 99 minutes.



12.17.FACTORY

Set FACTORY to restore the default settings (refer to  Default settings).

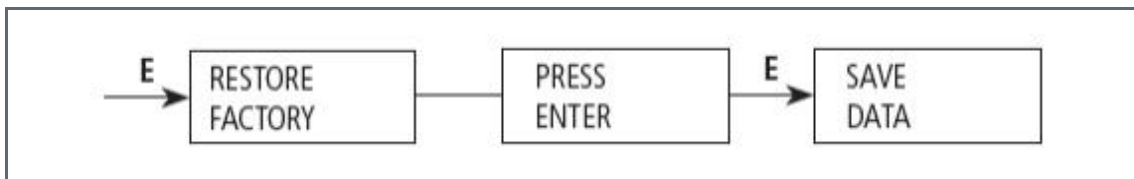

12.18.PASSW

Set PASSWORD to change default password (0000).



12.19.LANG

Set LANG to change language (ENGLISH or FRENCH).



12.20.MANUAL

MANUAL set pump manual dosing up to 99 minutes and 99 seconds. This menu allows to prime the pump.



12.21.ALARMS

If one or more alarms occur, they are listed on main menu.

Solve the problem and delete the alarm message pressing **↑**.

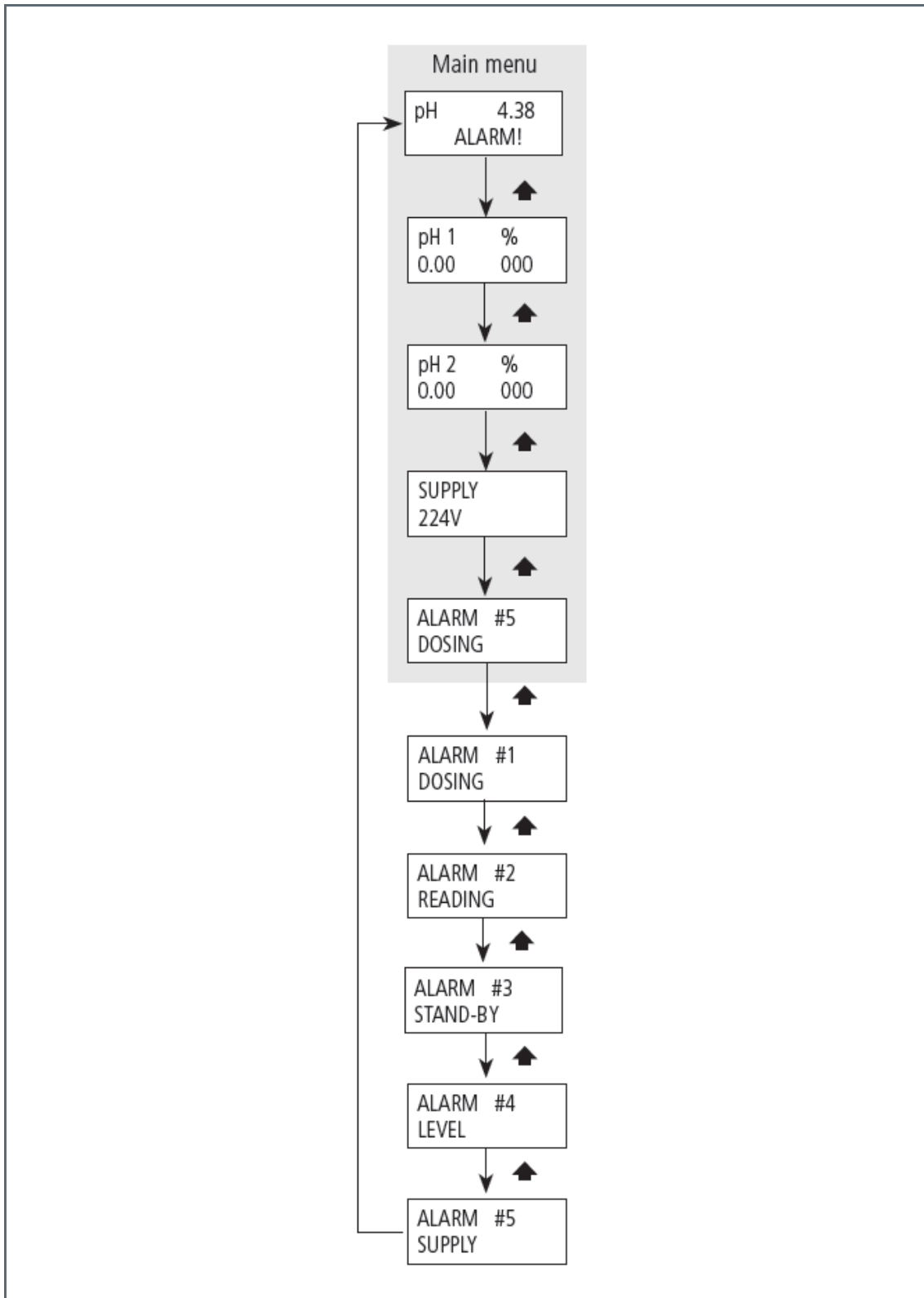

Documented alarms are:



ALARM	CAUSE	SOLUTION	
DOSING	Dosing time over the limit (refer to DOS AL into Setting menu).	Check the probe	Clean and calibrate. Eventually replace with a new probe
		Check pump: no/not enough feeding	Control and clean injection valve Control and clean foot filter Control and clean pump's valves Control solenoid
READING	Probe reading is not reliable. A probe failure is probable (refer to READ AL into Setting menu).	Check the probe	Clean and calibrate. Eventually replace with a new probe
		Check probe holder	Restore flow into probe holder
STAND-BY	No water flow.	Check probe holder	Restore flow into probe holder
		Check the flow into plant	Restore flow into plant
LEVEL	Empty tank	Fill the tank	Restore product into tank
SUPPLY	Supply voltage over the limit (refer to the label)	Check supply voltage	Delete alarm on display pressing ↑

Not documented alarms

ALARM	CAUSE	SOLUTION	
PH PROBE READING BLINKS ON DISPLAY	pH over the limit (0/14 pH)	Check probe	Clean and calibrate. Eventually replace with a new probe
		Check pump: too feeding	Control pump settings Control and clean injection valve
ORP PROBE READING BLINKS ON DISPLAY	ORP over the limit (-999/+999 mV)	Check probe	Clean and calibrate. Eventually replace with a new probe
		Check pump: too feeding	Control pump settings Control and clean injection valve

13. TROUBLESHOOTING

Table 4 Guide to troubleshooting

PROBLEM	CAUSE	REMEDY
Pump does not start	<ul style="list-style-type: none"> ▪ Pump not powered ▪ Protection fuse ▪ Main board 	<ul style="list-style-type: none"> ▪ Collegare la pompa alla rete elettrica ▪ Replace fuse  Fuse replacement procedure. ▪ Replace main board  Main board replacement procedure.
Pump does not feed but solenoid runs	<ul style="list-style-type: none"> ▪ Foot filter obstruction ▪ Pump head empty (suction pipe empty) ▪ Air bubbles into pump head or into suction pipe ▪ Product generates gas 	<ul style="list-style-type: none"> ▪ Clean the foot filter ▪ Prime the pump  PRIMING ▪ Check valves, pipes and fittings ▪ Open discharge knob and let air flow out. Use a self-venting pump head.
Pump does not feed, solenoid does not run or slightly run	<ul style="list-style-type: none"> ▪ Valves and/or ball valves blocked ▪ Injection valve obstruction 	<ul style="list-style-type: none"> ▪ Clean valves and ball valve. Feed 2-3 litres of water to wash valves and pump head ▪ Change valves



If the problem cannot be solved, please contact after-sales service or return the dosing pump to the manufacturer.

13.1. Repair service



Before return the dosing pump to the manufacturer Repair service, drain the chemical from pump head and rinse it. Refer to  Shutdown procedure.



If there is the possibility that residual corrosive liquid into pump head could cause damages, declare it on REPAIR FORM.



Fill the PRODUCT SERVICE REPAIR FORM and send it with the dosing pump.

Repair service is not accepted if PRODUCT SERVICE REPAIR FORM is missing.



13.2. Fuse replacement procedure

	Make sure that the product is isolated from the power supply and cannot be powered by mistake.
	This procedure SHOULD BE CARRIED OUT BY AUTHORIZED AND QUALIFIED PERSONNEL

In order to replace fuse, you need these tools:

- a 3x16 screwdriver
- a 3x15 screwdriver
- fuse (see  Features)
 - Unplug power supply and pipings.
 - Remove screws on the back of the pump.
 - Pull back cover until it's completely separated from pump's front. Be careful of the knob's spring.
 - Locate the fuse and replace with a new one.
 - Reassemble the pump.
 - Reinsert screws

13.3. Main board replacement procedure

	Make sure that the product is isolated from the power supply and cannot be powered by mistake.
	This procedure SHOULD BE CARRIED OUT BY AUTHORIZED AND QUALIFIED PERSONNEL

In order to replace main board, you need these tools:

- a 3x16 screwdriver
- a 3x15 screwdriver
- new main board.

- Unplug power supply and pipings.
- Remove screws on the back of the pump.
- Pull back cover until it's completely separated from pump's front. Be careful of the knob's spring.
- Remove boards screws..
- Completely disconnect wires from main board and replace it. Reinsert screws.
- Reconnect wires to the main board (☞ Main board scheme).
- Reassemble the pump.
- Reinsert screws.



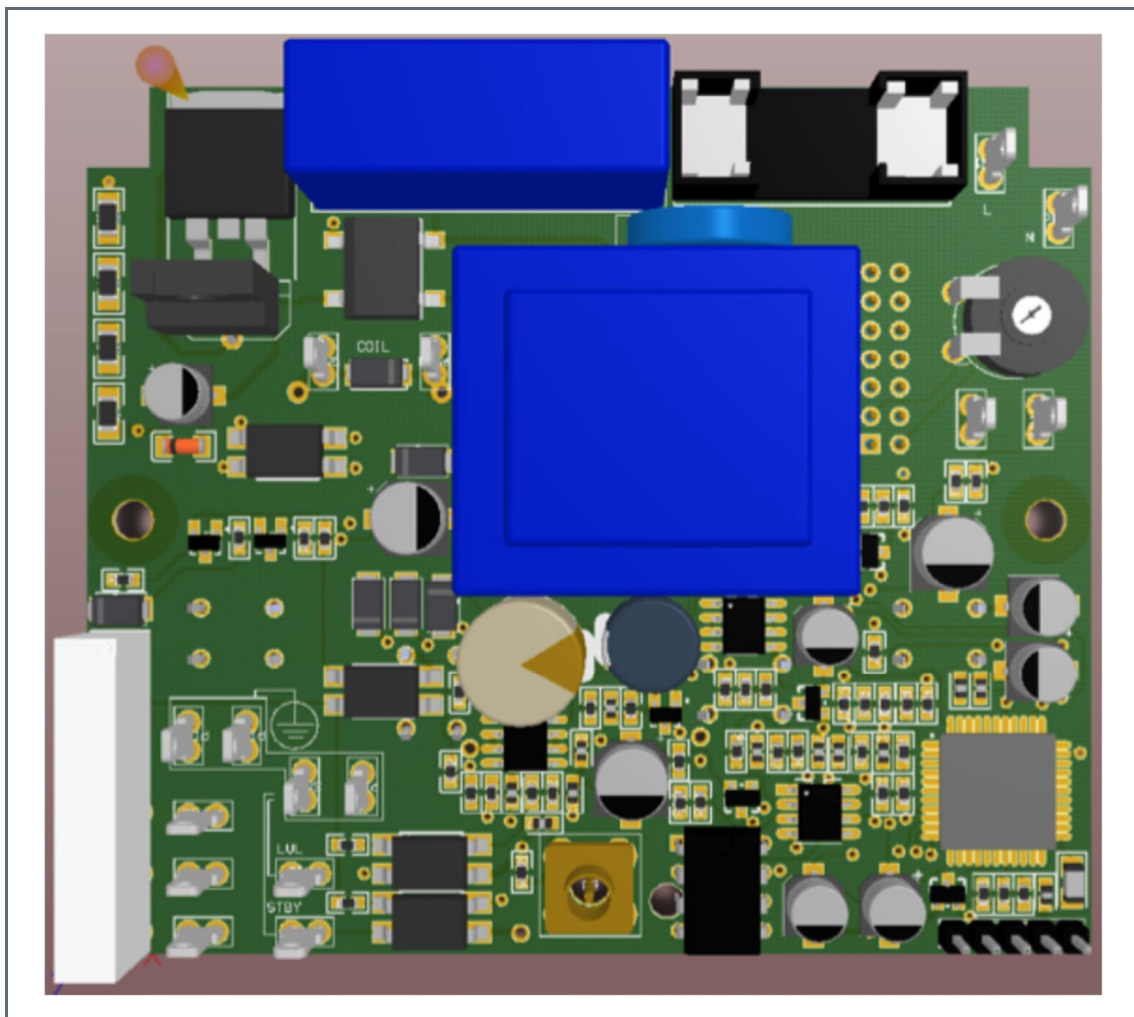

13.4. Main board

Figure 11 Main board scheme





14. MAINTENANCE

14.1. Maintenance schedule

	In order to ensure the requirements of potable drinking water treated and the maintenance of the improvements as declared by the manufacturer, this equipment must be checked at least once a month.
	OPERATOR PROTECTION Use safety equipment according to the company regulations. Use this safety equipment within the work area during installation, service and when handling chemicals: <ul style="list-style-type: none">▪ protective mask▪ protective gloves▪ safety goggles▪ ear plugs or hear muffs▪ further security device, if necessary.
	POWER SUPPLY DISCONNECTION Always disconnect power before you perform any installation or maintenance tasks. Failure to disconnect power will result in serious physical injury.
	Installation and maintenance tasks should be carried out by AUTHORIZED AND QUALIFIED PERSONNEL only in accordance with local regulations.
	Use original spare parts.

14.2. Maintenance inspection

	Shutdown the dosing pump before any maintenance operation  Shutdown procedure.
---	---

A maintenance schedule includes these types of inspections:

- Routine maintenance and inspections
- Three-month inspections
- Annual inspections

Shorten the inspection intervals appropriately if the pumped chemical is abrasive or corrosive.

Routine maintenance and inspections

Perform these tasks whenever you perform routine maintenance:

- Inspect the seal. Ensure that there are no leaks from the mechanical seal.
- Check electrical wiring
- Check for unusual noise and vibration (noise allowed 73 dbA; ± 5 dB).
- Check the pump and piping for leaks.
- Check for corrosion on parts of the pump and / or on hoses.

Three-month inspections

Perform these tasks every three months:

- Check that the tightenings.
- Check the mechanical seal if the pump has been left idle.

Annual inspections



Perform these inspections one time each year:

- Check the pump capacity (as per nameplate).
- Check the pump pressure (as per nameplate).
- Check the pump power (as per nameplate).

If the pump performance does not satisfy your process requirements, and the process requirements have not changed, then perform these steps:

1. Disassemble the pump.
2. Inspect it.
3. Replace worn parts.

14.3. Shutdown procedure

	This procedure SHOULD BE CARRIED OUT BY AUTHORIZED AND QUALIFIED PERSONNEL
	<p>OPERATOR PROTECTION</p> <p>Use safety equipment according to the company regulations.</p> <p>Use this safety equipment within the work area during installation, service and when handling chemicals:</p> <ul style="list-style-type: none">▪ protective mask▪ protective gloves▪ safety goggles▪ ear plugs or hear muffs▪ further security device, if necessary.

Shutdown the dosing pump before any maintenance operation or before long downtimes.

Disconnect power and ensure it cannot be restarted

	Depressurize the system. The liquid may leak splashing.
---	---

Drain the chemical from pump head.

Release the pressure and disconnect the discharge pipe from the discharge valve.

Rinse the pump head and clean all valves.

14.4. Delivery curves

Flow rate indicated is for H₂O at 20°C at the rated pressure.

Dosing accuracy $\pm 2\%$ at constant pressure $\pm 0,5$ bar.

Figure 12 VPO delivery curves

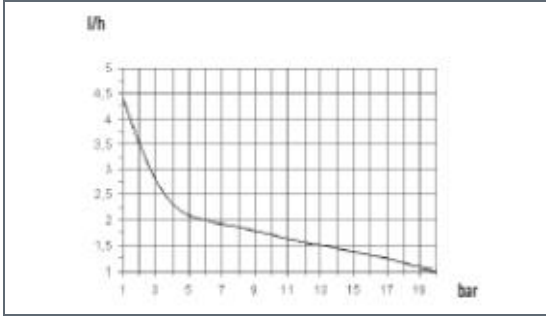

2001: l/h 1 bar 20
Pump head mod. J

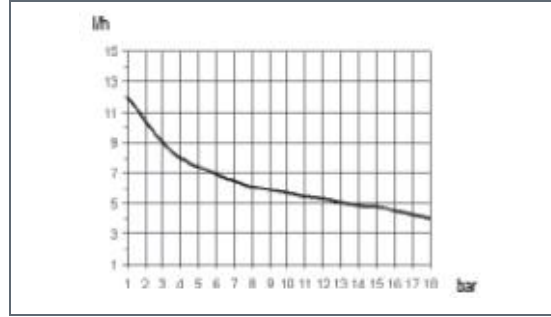

1804: l/h 4 bar 18
Pump head mod. K

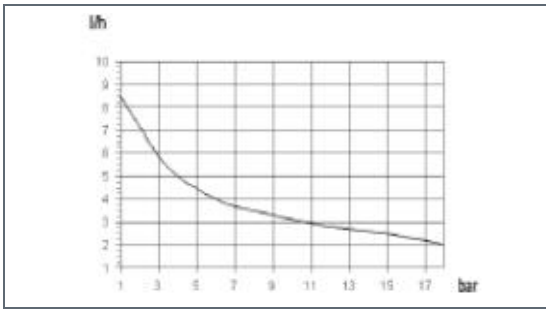

1802: l/h 2 bar 18
Pump head mod. K

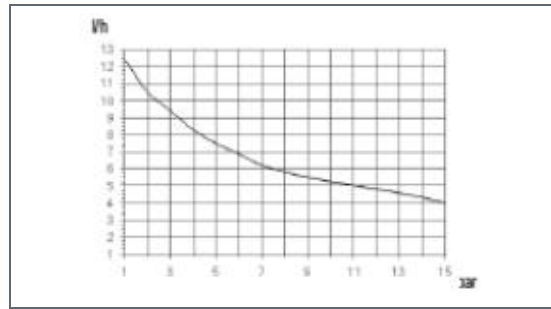

1504: l/h 4 bar 15
Pump head mod. K

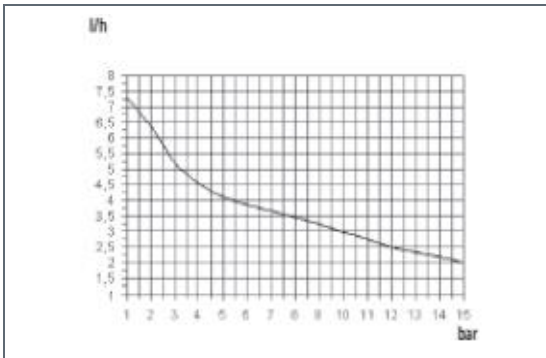

1502: l/h 2 bar 15
Pump head mod. K

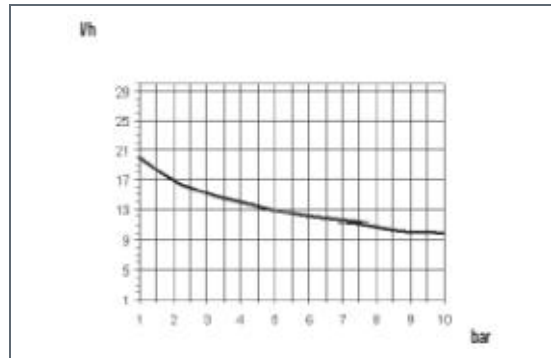

1010: l/h 10 bar 10
Pump head mod. K

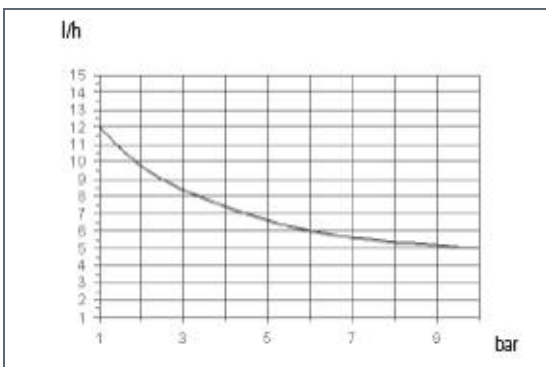

1005: l/h 5 bar 10
Pump head mod. K

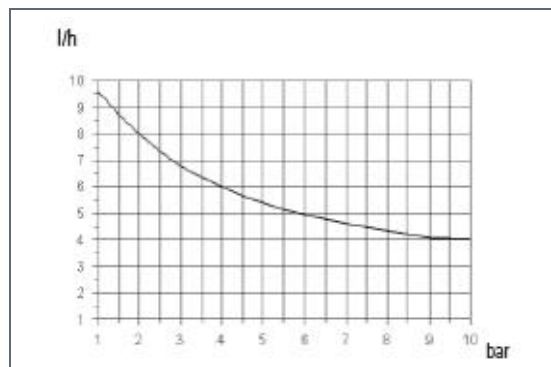

1004: l/h 4 bar 10
Pump head mod. K

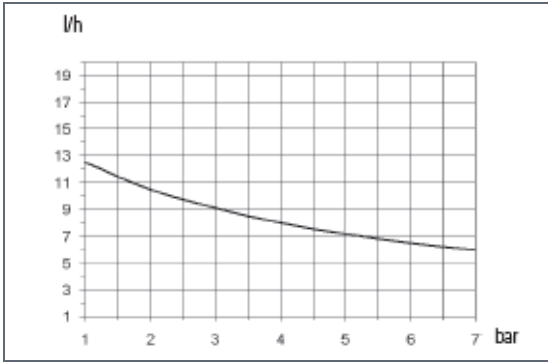

0706: l/h 6 bar 7
Pump head mod. K

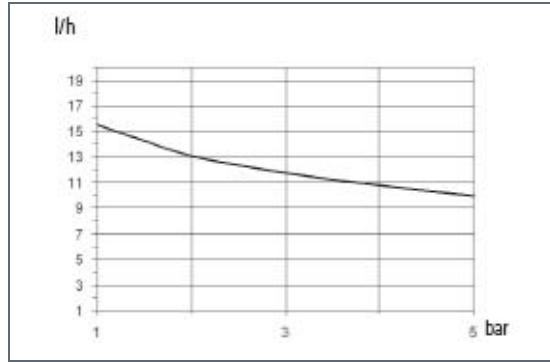

0510: l/h 5 bar 10
Pump head mod. K

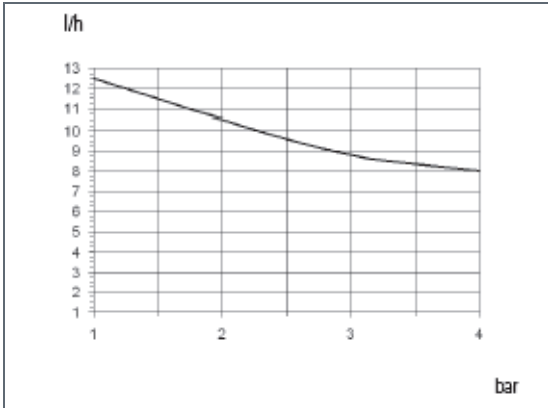

0408: l/h 8 bar 4
Pump head mod. K

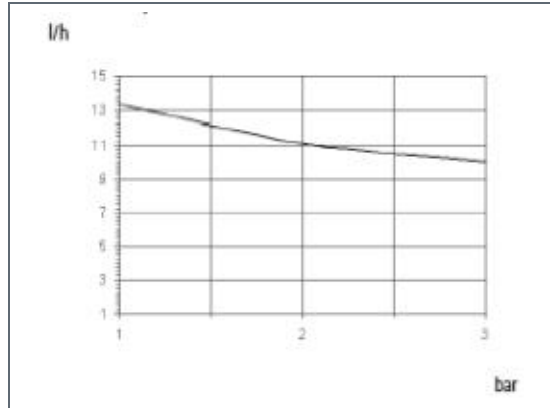

0310: l/h 10 bar 3
Pump head mod. K

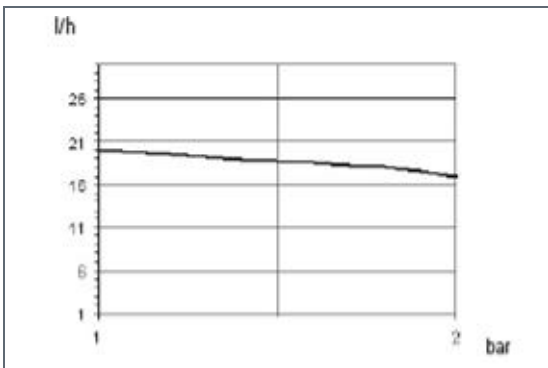

0217: l/h 17 bar 2
Pump head mod. K

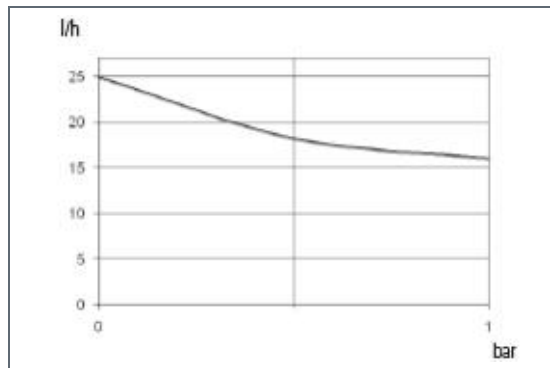

0116: l/h 16 bar 1
Pump head mod. K

Figure 13 VAPO delivery curves

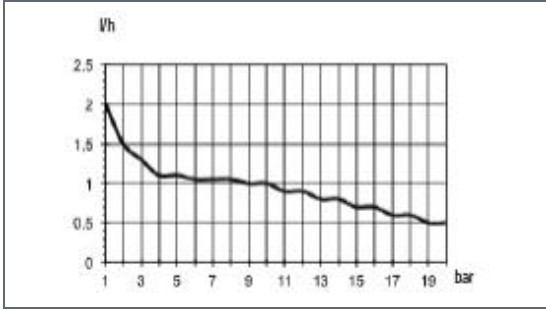

200.5: I/h 0.5 bar 20
Pump head mod. JA

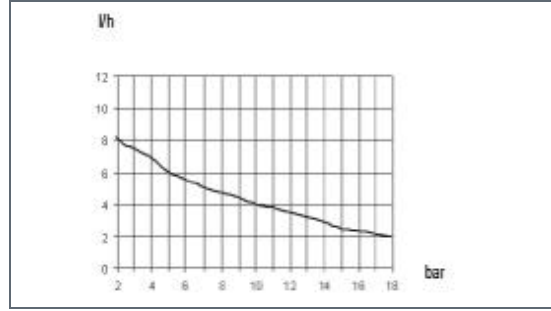

1802: I/h 2 bar 18
Pump head mod. KA

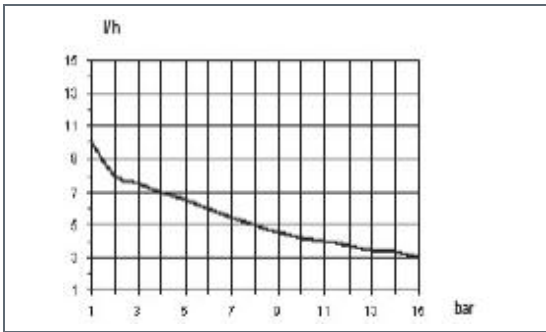

1503: I/h 3 bar 15
Pump head mod. KA

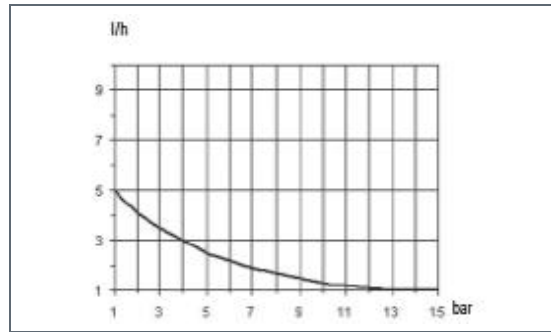

1501: I/h 1 bar 15
Pump head mod. KA

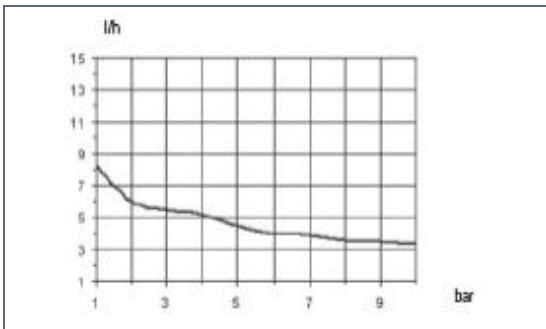

103.4: I/h 3.4 bar 10
Pump head mod. KA

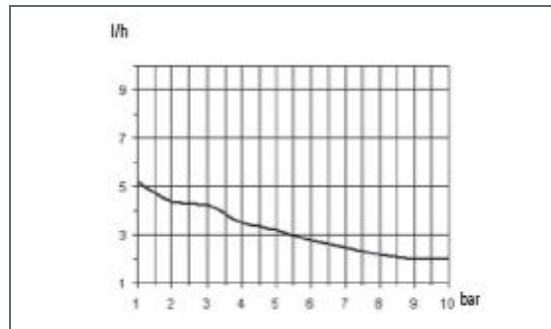

1002: I/h 2 bar 10
Pump head mod. KA

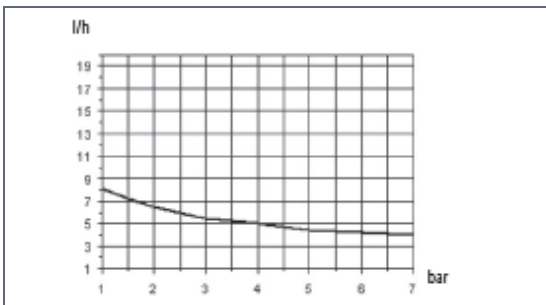

0704: I/h 4 bar 7
Pump head mod. KA

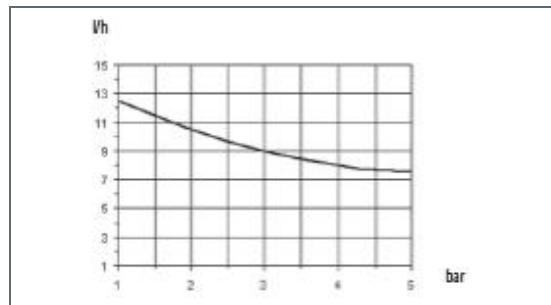

057.5: I/h 7.5 bar 5
Pump head mod. KA

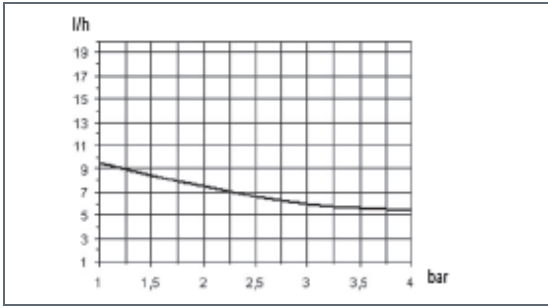

045.5: l/h 5.5 bar 4
Pump head mod. KA

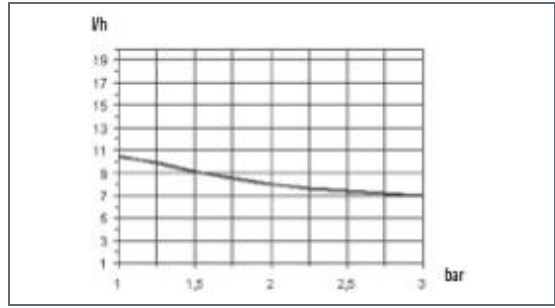

0307: l/h 7 bar 3
Pump head mod. KA

14.5. Dimensions

Figure 14 Dimensions

DIMENSIONS	mm	inch
A	106.96	4.21
B	210.44	8.28
C	199.44	7.85
D	114.50	4.50
E	187.96	7.40
F	97.00	3.81
G	106.96	4.21
H	125.47	4.93
L	50.00	1.96
M	201.00	7.91

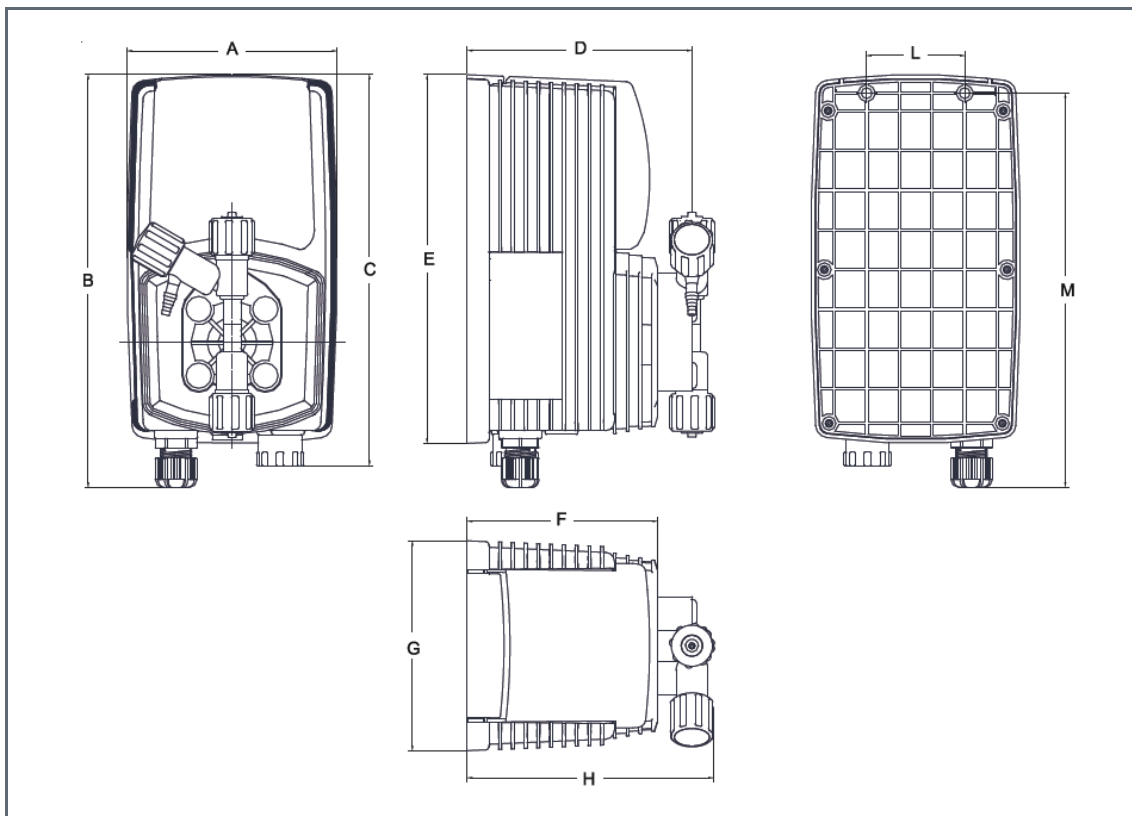

15. COMPATIBILITY TABLE

15.1. Chemical compatibility table

Solenoid driven metering pumps are widely used to dose chemical fluids and it is important that the most suitable material in contact with fluid is selected for each application. This compatibility table serves as a useful help in this respect. All the informations in this list are verified periodically and believed to be correct on the date of issuance. All the informations in this list are based on manufacturer's data and its own experience but since the resistance of any material depends by several factors this list is supplied only as an initial guide, in no way manufacturer makes warranties of any matter respect to the informations provided in this list.

Table 5 Chemical compatibility table.

PRODUCT	Formula	Ceram.	PVDF	PP	PVC	SS 316	PMMA	Hastel.	PTFE	FPM	EPDM	NBR	PE
Acetic Acid, Max 75%	CH ₃ COOH	2	1	1	1	1	3	1	1	3	1	3	1
Hydrochloric Acid, Concentrate	HCl	1	1	1	1	3	1	1	1	1	3	3	1
Hydrofluoric Acid 40%	H ₂ F ₂	3	1	3	2	3	3	2	1	1	3	3	1
Phosphoric Acid, 50%	H ₃ PO ₄	1	1	1	1	2	1	1	1	1	1	3	1
Nitric Acid, 65%	HNO ₃	1	1	2	3	2	3	1	1	1	3	3	2
Sulphuric Acid, 85%	H ₂ SO ₄	1	1	1	1	2	3	1	1	1	3	3	1
Sulphuric Acid, 98.5%	H ₂ SO ₄	1	1	3	3	3	3	1	1	1	3	3	3
Amines	R-NH ₂	1	2	1	3	1	-	1	1	3	3	1	1
Sodium Bisulphite	NaHSO ₃	1	1	1	1	2	1	1	1	1	1	1	1
Sodium Carbonate (Soda)	Na ₂ CO ₃	2	1	1	1	1	1	1	1	2	1	1	1
Ferric Chloride	FeCl ₃	1	1	1	1	3	1	1	1	1	1	1	1
Calcium Hydroxide (Slaked Lime)	Ca(OH) ₂	1	1	1	1	1	1	1	1	1	1	1	1
Sodium Hydroxide (Caustic Soda)	NaOH	2	3	1	1	1	1	1	1	2	1	2	1
Calcium Hypochlor. (Chlorinated Lime)	Ca(OCl) ₂	1	1	1	1	3	1	1	1	1	1	3	1

Sodium Hypochlorite, 12.5%	NaOCl + NaCl	1	1	2	1	3	1	1	1	1	1	2	3
Potassium Permanganate, 10%	KMnO4	1	1	1	1	1	1	1	1	1	1	3	1
Hydrogen Peroxide, 30% (Perydrol)	H2O2	1	1	1	1	1	3	1	1	1	3	3	1
Aluminium Sulphate	Al2(SO4)3	1	1	1	1	1	1	1	1	1	1	1	1
Copper-II-Sulphate (Roman Vitriol)	CuSO4	1	1	1	1	1	1	1	1	1	1	1	1

1 - Good resistance rating

2 - Fairly resistance rating

3- Not resistant

15.2. Materials

Polyvinylidene fluoride (PVDF)	Pump heads, Valves, Fittings
Polypropylene (PP)	Pump heads, Valves, Fittings
PVC	Pump heads
Stainless steel (SS 316)	Pump heads, Valves
Polymethyl Metacrilate Acrylic (PMMA)	Pump heads
Polytetrafluoroethylene (PTFE)	Diaphragm
Fluorocarbon (FPM)	O-ring
Ethylene propylene (EPDM)	O-ring
Nitrile (NBR)	O-ring

15.3. Hose resistance table

Hose features are very important for a reliable dosage. Every pump's model is made to work in the best way using selected hoses according to pump's capacity / model. Information reported here are intended for standard use only. For extended information ask to hose's manufacturer.

Table 6 Hoses features

Suction / Delivery Hose								
4x6 mm PVC (transparent)	4x8 mm PE (opaque)		6x8 mm PE (opaque)		8x12 mm PVC (transparent)			
Delivery Hose	Working Pressure				Breaking pressure			
4x6 mm PE 230 (opaque)	20°C 12 bar	30°C 10.5 bar	40°C 8.5 bar	50°C 6.2 bar	20°C 36 bar	30°C 31.5 bar	40°C 25.5 bar	50°C 18.2 bar
4x8 mm PE 230 (opaque)	20°C 19 bar	30°C 15.7 bar	40°C 12 bar	50°C 7.5 bar	20°C 57 bar	30°C 47 bar	40°C 36 bar	50°C 22.5 bar
6x8 mm PE 230 (opaque)	20°C 8.6 bar	30°C 6.8 bar	40°C 4.8 bar	50°C 2.3 bar	20°C 26 bar	30°C 20.5 bar	40°C 14.5 bar	50°C 7 bar
8x12 mm PE 230 (opaque)	20°C 12 bar	30°C 10.5 bar	40°C 8.5 bar	50°C 6.2 bar	20°C 36 bar	30°C 31.5 bar	40°C 25.5 bar	50°C 18.2 bar
4x6 mm PVDF Flex 2800 (opaque)	20°C 40 bar	30°C 34 bar	40°C 30 bar	50°C 27 bar	60°C 24.8 bar	80°C 20 bar	90°C 10 bar	
6x8 mm PVDF Flex 2800 (opaque)	20°C 29 bar	30°C 25.5 bar	40°C 22 bar	50°C 20 bar	60°C 18 bar	80°C 14.5 bar	90°C 7.3 bar	
8x10 mm PVDF Flex 2800 (opaque)	20°C 18 bar	30°C 15.5 bar	40°C 13.5 bar	50°C 12.5 bar	60°C 11.2 bar	80°C 9 bar	90°C 4.5 bar	
1/4 PE 230 (opaque)	20°C 17.6 bar							
3/8 PE 230 (opaque)	20°C 10.6 bar							
1/2 PE 230 (opaque)	20°C 10.6 bar							

PRODUCT SERVICE REPAIR FORM

MOD 7.5 B1 Q
Ed. 1 - rev. 0 21/02/2012

ENCLOSE THE PRESENT FORM TO THE DELIVERY NOTE

DATE

SENDER
 Company name
 Address
 Phone no.
 Contact person.....

PRODUCT TYPE (see product label)

DEVICE CODE
S/N (serial number).....

OPERATING CONDITIONS

Location/installation description
.....
Chemical
Start-up (date) Running time (approx. hours).....

REMOVE ALL THE LIQUID INTO THE PUMP HEAD AND DRY IT BEFORE PACKAGING IN ITS ORIGINAL BOX.

DESCRIPTION OF PROBLEM

- MECHANICAL
 - Wear parts
 - Brekage/other damages
 - Corrosion
 - Other
- ELECTRICAL
 - Connections, connector, cables
 - Operating controls (keyboard, display, etc.)
 - Eletronics
 - Other
- LEAKS
 - Connections
 - Pump head
- NOT OR INADEQUATE FUNCTION/OTHER
 -
 -
 -

I declare that the dosing pump is free of any hazardous chemical.

39

Signature of the compiler

Company stamp